



BOWMAN®



Dispensers

Organize • Contain • Comply

2018 catalog

GLOVE BOX DISPENSERS

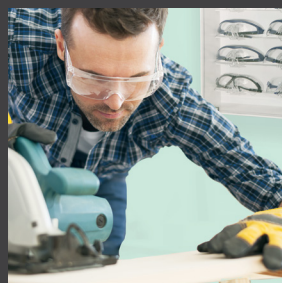

P P E D I S P E N S I N G S O L U T I O N S F O R E V E R Y M A R K E T

adaptable

TO ANY SETTING



Food Service



Business



Laboratory



Industrial



Healthcare



Dental



Construction



Education

- (ABS)** ABS Plastic 02
- (AFP)** ABS Fauxwood Plastic 02
- (ALM)** Aluminum 05
- (CRS)** Cold Rolled Steel 04
- (PET)** PETG Plastic 01

- (PLC)** Polycarbonate Plastic 12
- (STP)** Sintra® Plastic 07
- (STS)** Stainless Steel 03
- (WIR)** Powder-Coated Wire 06

material

- (●)** Bay Gray 29
- (●)** Black 20
- (●)** Cherry 33
- (●)** Maple 23
- (●)** Stainless Steel 00

- (○)** Clear 11
- (○)** Frosted Clear 14
- (○)** Quartz Beige 12
- (○)** White 13, 34

color

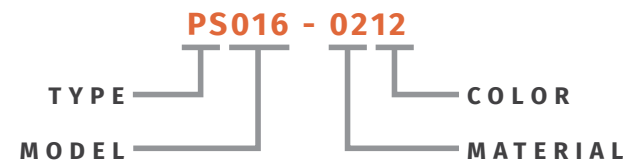

Example: **PS016-0212**
Protection System, Model 016, ABS, Quartz Beige

number

find your solution

- Glove Box Dispensers.....4**
 - Divided5
 - Non-Divided.....10
 - Specialty13
- Signature Series.....16**
- Construction & Renovation.....18**
- Build A Room 20**
- Index.....21**

learn more:
[BowmanDispensers.com/](http://BowmanDispensers.com/Product-Videos)
Product-Videos



Visit our website for extended material and color information. Colors may vary. Not all colors or materials are available for all dispensers. Use the material codes shown in this catalog as a reference for what a particular dispenser is made from. Custom options are also available.



PERFECT FIT

universal appeal

Glove Box Dispensing Solutions from BOWMAN fit any industry and organizational need:

- Material options for any budget
- Different finishes for any interior
- Top, right, and left loading options
- Vertical and horizontal mounting choices
- Single, double, triple, and quad layouts
- Minimal to full glove box visibility
- Changing suppliers means you can keep using the same dispensers, as BOWMAN accommodates most brands



Divided Glove Box Dispensers

ABS Fauxwood Plastic - Cherry (AFP)
DIVIDED



GL010-0233 (AFP)
Single

ABS Fauxwood Plastic - Maple (AFP)
DIVIDED



GL020-0223
Double



GL020-0233 (AFP)
Double



GL030-0233 (AFP)
Triple



GL040-0233 (AFP)
Quad



GL010-0223 (AFP)
Single



GL030-0223 (AFP)
Triple



GL040-0223 (AFP)
Quad

ABS Plastic - Quartz Beige
DIVIDED



top seller **GL300-0212** (ABS)
Triple



top seller **GL100-0212** (ABS)
Single

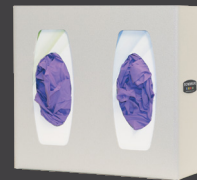

GL020-0212 (ABS)
Double



GL040-0212 (ABS)
Quad

Powder-Coated Steel - White
DIVIDED



GB-001 (CRS)
Single



GL002-0413 (CRS)
Double



GL003-0413 (CRS)
Triple



GL004-0413 (CRS)
Quad

Stainless Steel
DIVIDED



GS-124 (STS)
Quad



GS-004 (STS)
Single



GS-122 (STS)
Double



GS-123 (STS)
Triple

easy

RESTOCK

Divided glove box dispensers allow quick replacement of empty boxes without disrupting the whole unit.

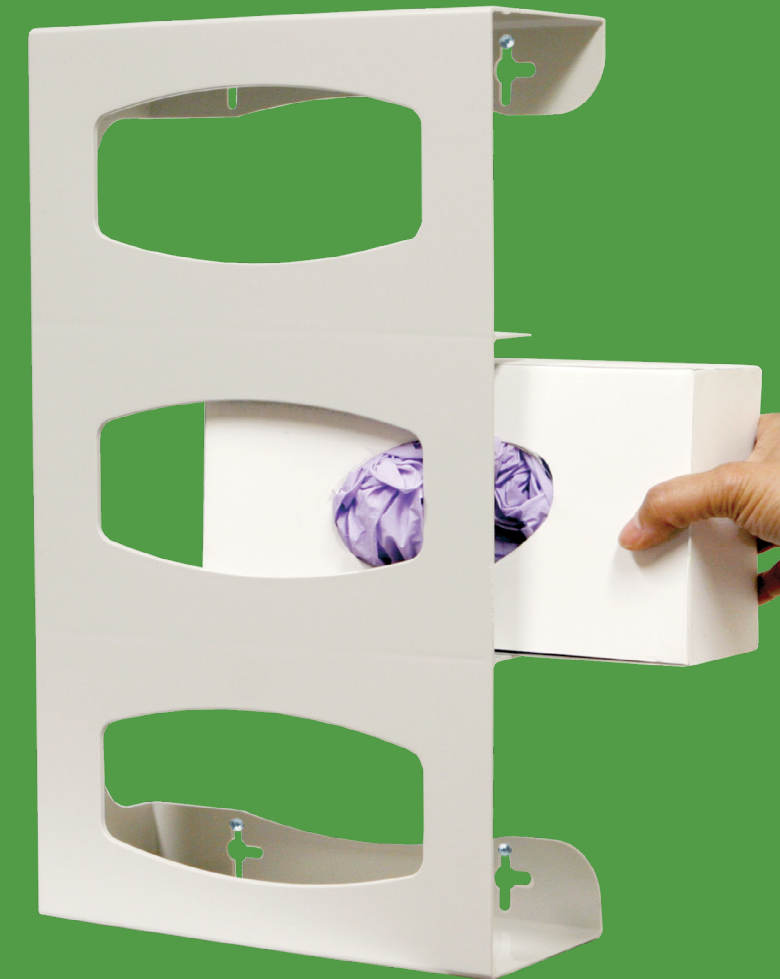

All consumable items are for demonstration purposes only and are not available for purchase through BOWMAN®

Clear PETG & Polycarbonate Plastic
DIVIDED



top seller **GL300-1214** (PLC)
Triple



top seller **GL100-1214** (PLC)
Single



GL020-0111 (PET)
Double



GL040-0111 (PET)
Quad



strong

WE'RE NOT AFRAID TO SHOW
YOU WHAT WE'RE MADE OF

High Quality BOWMAN Glove Box Dispensers are
manufactured with materials that work in extreme
environments, and can withstand frequent use of harsh
cleaning agents—without weakening or discoloring.



learn more about
quality plastics:
[BowmanDispensers.com/
Product-Videos](http://BowmanDispensers.com/Product-Videos)

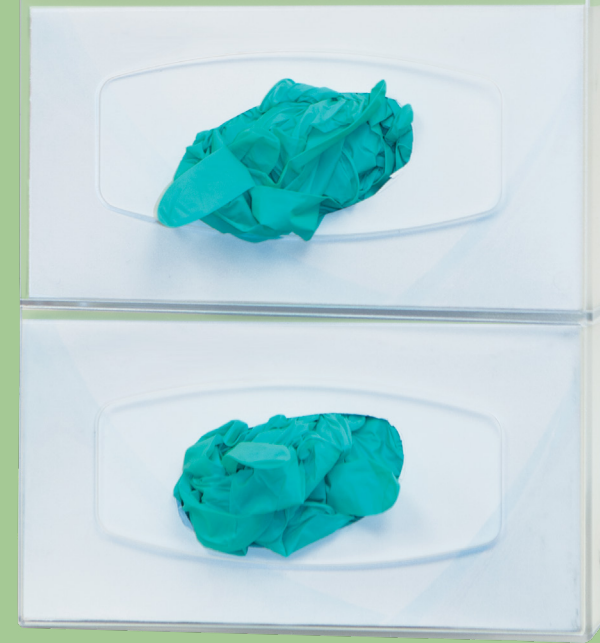

PETG

- Extreme clarity and light transmission
- High gloss surface finish
- Can bend, twist, and endure most impacts without breaking

ABS

- Strong & Flexible
- Opaque
- Used for products including camera bodies and power tools

POLYCARB (shown above)

- Naturally transparent thermoplastic
- High impact strength
- Used for products such as eyeglass lenses & bullet-proof glass

steer clear of acrylic

THE BRITTLE
INDUSTRY
SUBSTITUTE

- Discolors with alcohol & hospital cleaners
- Weak & breaks easily
- Susceptible to stress cracks
- Hidden costs: replacement
- Manufactured overseas

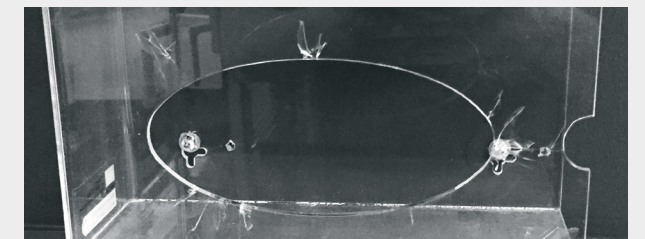

Competitor's acrylic products,
like the dispenser shown above,
carry **warning labels** for high
fragility and shattering potential.

Non-Divided Glove Box Dispensers

Clear PETG Plastic
NON-DIVIDED

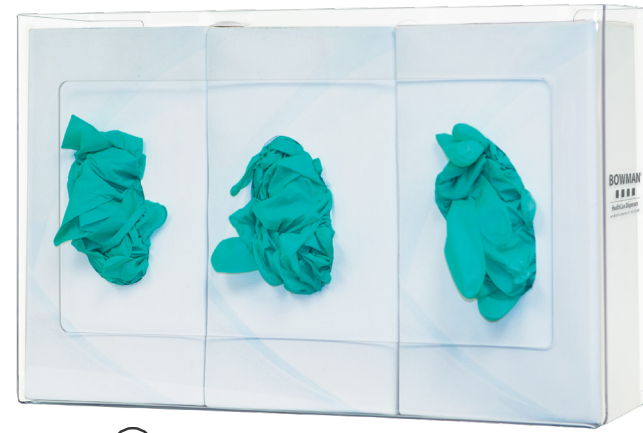

GP-015 (PET)
Triple



GP-013 (PET)
Single



GP-014 (PET)
Double



GP-061 (PET)
Quad

Coated Wire - White
NON-DIVIDED

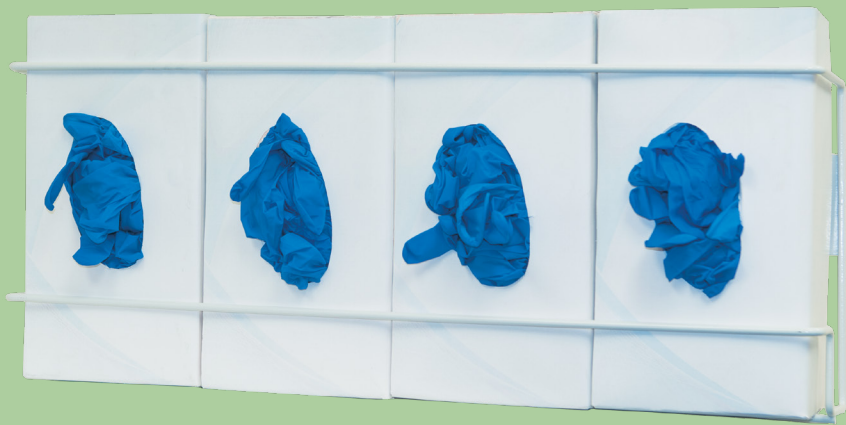

GL044-0613* (WIR)
Quad



GL011-0613* (WIR)
Single



GL022-0613* (WIR)
Double

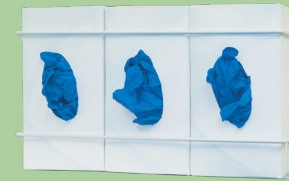

GL033-0613* (WIR)
Triple

*IMPORTED

Powder-Coated Steel - White
NON-DIVIDED



GB-001 (CRS)
Single



GB-002 (CRS)
Double



GB-003 (CRS)
Triple



GB-059 (CRS)
Quad

Stainless Steel
NON-DIVIDED



GS-005 (STS)
Double



GS-004 (STS)
Single



GS-006 (STS)
Triple

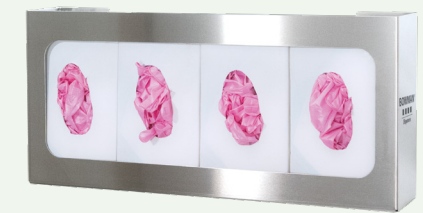

GS-060 (STS)
Quad

Extra Narrow
FOOD SERVICE



GL102-0300 (STS)

Single - Extra Narrow

Fits boxes no larger than 4.95"W x 9.04"H x 2.82"D
(12.6 cm x 23.0 cm x 7.2 cm)

Also available - Clear PETG Plastic - GL102-0111 (PET)

[cross reference: online](#)

Narrow
STANDARD



GP-073 (PET)

Triple - Narrow

Fits boxes no larger than 15.95"W x 10.10"H x 2.95"D
(40.5 cm x 25.7 cm x 7.5 cm)

Also available - Single - GP-071 (PET), and Double - GP-072 (PET)

Vertical Space Saver
TOP LOADING



GP-107 (PET)

Triple - Space Saver

Also available:
Double - GP-106

GB-068 (CRS)

Triple - Space Saver

Also available:
Double - GB-067

GS-109 (STS)

Triple - Space Saver

Also available:
Double - GS-108



Vertical Top Loading
CLEAR PETG PLASTIC



GP-310 (PET)

Single - Top Load



GP-320 (PET)

Double - Top Load



GP-330 (PET)

Triple - Top Load



GP-340 (PET)

Quad - Top Load

compatible

BOWMAN Glove Box Dispensers come in a myriad of sizing and color options to integrate seamlessly into any environment. Whether you need a standard place to store a few boxes of gloves, or have many rooms and varieties of gloves to organize, BOWMAN has your perfect fit.

Top Loading and Space Saver Glove Box Dispensers are loaded from the top only and therefore require that all glove boxes be removed to replace the bottom box

All consumable items are for demonstration purposes only and are not available for purchase through BOWMAN®

versatile

MOUNTING OPTIONS



Three-Way Keyholes allow Glove Box Dispensers to be permanently mounted in the direction of your choice:

- Choose horizontal or vertical mount based on loading preference or space availability
- Use hardware recommended by building or maintenance staff

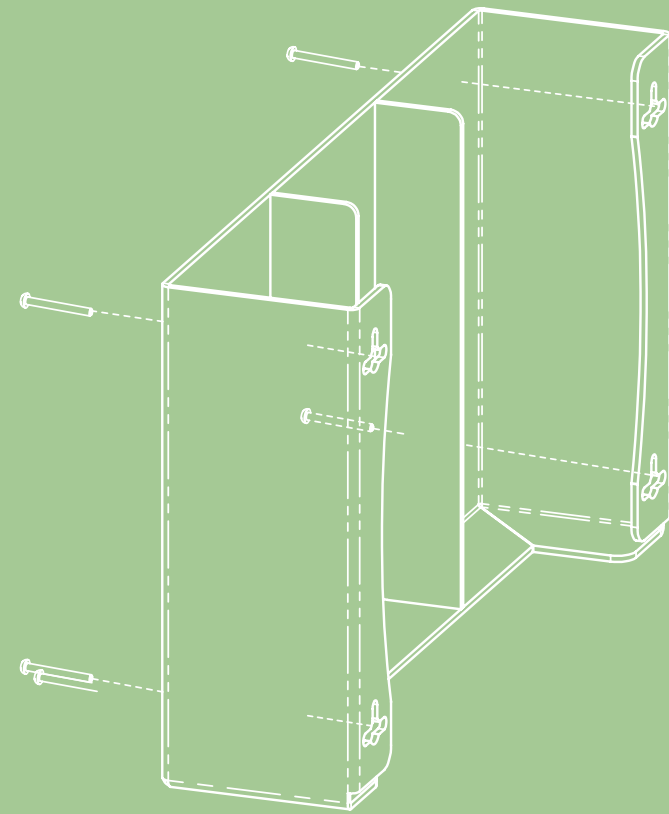

→ Left Load



↓ Top Load



Right Load ←

Recessed

- One in-wall well with adjustable shelving
- Keyless, quarter-turn lock to secure door
- Optional glove size indicator
- Innovative and aesthetically pleasing design



RE301-0012 **new product**
Triple
12.34"W x
18.83"H x
4.77"D



RE404-0012 **new product**
Quad
12.34"W x
24.48"H x
4.77"D



RE401-0012 **new product**
Triple with Earloop
Face Mask Dispenser
12.34"W x
24.48"H x
4.77"D

Overall external dimensions.

Interior Cabinet

- A great option for locations where a built-in look is preferred
- Frees up space on countertops and walls, while allowing easy access to essentials
- Available for select BOWMAN dispensers and custom designed products



GB-144
Single
Unmounted View



GL300-1214
Triple with Dividers

Top: Inside pre-cut cabinet
Left: In use inside dental office
(Photo provided by Cabinet Plus, Inc.)



recessed video:
[BowmanDispensers.com/
Product-Videos](http://BowmanDispensers.com/Product-Videos)

organized
& EASY TO ACCESS



Signature Series: naturally

SUITED TO YOUR SPACE

Signature Series FEATURES:

- Natural woodgrain appearance compliments any interior
- All styles shown available in Cherry or Maple Fauxwood
- Visually appealing, upscale option
- Increases customer satisfaction
- Strong and durable
- Easy to clean; stands up to hospital grade cleaners
- Most BOWMAN dispensers can be custom ordered with Signature Series materials; minimum order quantities may apply

Cover Your Cough Kits

Everything you need in one convenient kit.

BD212-0023 (AFP)

Countertop or Wall Mount Station & Sign
Also available in Cherry - BD212-0033



BD111-0033 (AFP)

Freestanding Station, Stand & Sign
Also available in Maple - BD111-0023



Glove Box Dispensers

Three-way keyholes for vertical or horizontal mounting.



GL010-0223 (AFP)

Also available in Cherry - GL010-0233



GL020-0233 (AFP)

Also available in Maple - GL020-0223



GL030-0223 (AFP)

Also available in Cherry - GL030-0233



GL040-0233 (AFP)

Also available in Maple - GL040-0223

Protection Systems

Mount to wall, door or glass: visit our website for more details.



PS016-0233 (AFP)



PS016-0223 (AFP)

Individual colors may vary | All consumable items are for demonstration purposes only and are not available for purchase through BOWMAN®

Success is in the details

Integrate PPE Dispensing Solutions into the project planning phase to save space, improve aesthetics and reduce code violations.



value adds FOR EVERY PROJECT

- Recessed, Interior Cabinet, Custom & Stock PPE Dispensing Solutions
- Material options for any budget
- Finish options for any interior
- All products offer best functionality and quality aesthetics
- Strong materials withstand heavy use & hospital grade cleaning products

Get started today: 800-962-4660



free planning tools:
Find our Hospital Dispenser Planning Checklist and more at BowmanDispensers.com



build a room:
Plan and arrange dispensers using a photograph of your space (see pg 20)



learn more:
BowmanDispensers.com/Product-Videos

Recessed Solutions

BEAUTIFULLY COMPLIANT

- Keeps high traffic areas clear & avoids wall protrusion rules
- Variety of layout options for Glove Dispensing, Flu Prep, & Protection Systems
- Available through the BOWMAN Custom Design Program



RE101-0012 (CRS)
Protection System - Standard
24.36"W x 27.65"H x 4.77"D

More recessed options:
Gloves - pg 37
Face Masks - pg 38

Interior Cabinet Dispensing

BUILT-IN ESSENTIALS

- Frees up space on countertops and walls with a polished look
- Available for select stock dispensers & any custom designed products



GB-144 (CRS)
Glove Box Dispenser - Single
Unmounted View



GL300-1214 (PLC)
Glove Box Dispenser - Triple with Dividers
Left: Side view; Right: cabinet & inside dental office



Ready-to-Install Stock Designs

EASY OPTIONS

- A variety of colors and materials
- Expedited shipping available for quick turn-around projects
- Some of our best sellers are shown below; browse through the catalog to see a large variety of options



NC001-0512 (ALM)
Bedpan/Urinal
Dispenser



GL030-0223 (AFP)
Glove Box Dispenser
Triple with Dividers

Custom Designs

UNIQUE LOCATION SOLUTIONS

- If you can dream it, we can do it
- Minimum order quantities may apply

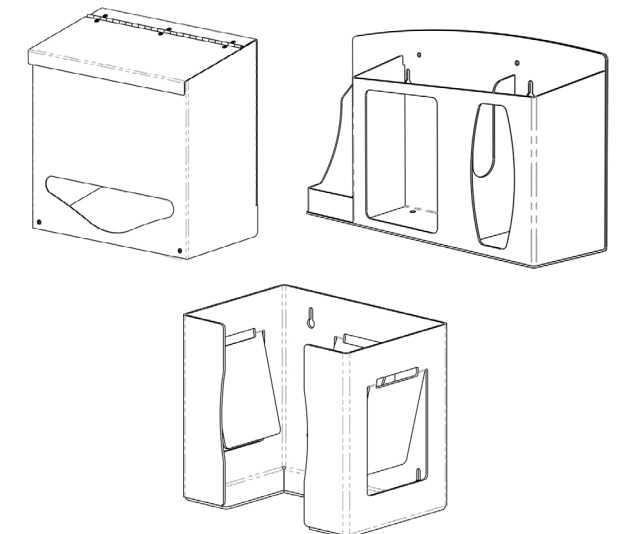

Build A Room by BOWMAN

Build A Room shows you the end result in just a few clicks with a camera and a mouse. Create, save and output an image of your ideal room, like the one shown at right. Visit: BuildARoomByBowman.com



Create your ideal working environment in just a few easy steps at BuildARoomByBowman.com:



Choose the consumable(s) and room(s) that need organization.



Tape an 8 1/2" x 11" piece of paper to the wall and take a photo straight on of the room.



Select your room type in Build A Room and upload your photo.

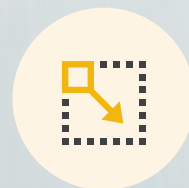

Arrange the yellow square to fill your paper in the photo.



Drag and drop dispensers into your space.



Save your design then print or send your layout to your planning team.

Part Number	Product Name	Page	Unit	W (L)	H	D	Product Weight
BD111-0033	Cover Your Cough Compliance Kit with Vertical Sign Holder - Includes: RS001-0233, KS010-0420, MP-070	16	IN	18.00	58.36	18.00	LB 18.8
			CM	45.7	148.2	45.7	KG 8.5
BD212-0023	Cover Your Cough Compliance Kit with Horizontal Sign Holder - Includes: RS001-0223, MP-075	16	IN	17.90	19.80	4.45	LB 3.3
			CM	45.5	50.3	11.3	KG 1.5
GB-001	Glove Box Dispenser - Single Flexible Spring - White Powder-Coated Steel	7, 11	IN	5.60	9.96	3.80	LB 1.4
			CM	14.2	25.3	9.7	KG 0.6
GB-002	Glove Box Dispenser - Double - White Powder-Coated Steel	11	IN	10.56	10.03	3.81	LB 1.6
			CM	26.8	25.5	9.7	KG 0.7
GB-003	Glove Box Dispenser - Triple - White Powder-Coated Steel	11	IN	15.81	10.03	3.81	LB 1.8
			CM	40.2	25.5	9.7	KG 0.8
GB-059	Glove Box Dispenser - Quad - White Powder-Coated Steel	11	IN	22.32	9.99	3.81	LB 2.7
			CM	56.7	25.4	9.7	KG 1.2
GB-067	Glove Box Dispenser - Double - Space Saver - White Powder-Coated Steel	Not Pictured	IN	5.60	20.04	3.94	LB 2.5
			CM	14.2	50.9	10.0	KG 1.1
GB-068	Glove Box Dispenser - Triple - Space Saver - White Powder-Coated Steel	13	IN	5.50	30.04	3.94	LB 3.5
			CM	14.0	76.3	10.0	KG 1.6
GB-074	Glove Box Dispenser - Single - Large Capacity with Flexible Spring - White Powder-Coated Steel	Not Pictured	IN	6.50	9.96	3.80	LB 1.6
			CM	16.5	25.3	9.7	KG 0.7
GB-144	Glove Box Dispenser - Single with Flexible Spring - Cabinet Mount - White Powder-Coated Steel	15, 18	IN	5.60	10.00	3.80	LB 1.4
			CM	14.2	25.4	9.7	KG 0.6
GC-009	Glove Dispenser - Bulk - White Sintra® Plastic	Not Pictured	IN	5.05	11.21	4.45	LB 0.6
			CM	12.8	28.5	11.3	KG 0.3
GC-018	Glove Box Dispenser - Single with Flexible Spring - White Sintra® Plastic	Not Pictured	IN	5.80	10.06	4.07	LB 0.5
			CM	14.7	25.6	10.3	KG 0.2
GL002-0413	Glove Box Dispenser - Double with Divider - White Powder-Coated Steel	7	IN	10.60	10.03	3.82	LB 2.3
			CM	26.9	25.5	9.7	KG 1.0
GL003-0413	Glove Box Dispenser - Triple with Dividers - White Powder-Coated Steel	7	IN	15.87	10.03	3.81	LB 2.3
			CM	40.3	25.5	9.7	KG 1.0
GL004-0413	Glove Box Dispenser - Quad with Dividers - White Powder-Coated Steel	7	IN	21.19	10.00	3.81	LB 2.4
			CM	53.8	25.4	9.7	KG 1.1
GL010-0223	Glove Box Dispenser - Single - Maple Fauxwood ABS Plastic	5, 17	IN	5.75	10.13	4.00	LB 0.8
			CM	14.6	25.7	10.2	KG 0.4
GL010-0233	Glove Box Dispenser - Single - Cherry Fauxwood ABS Plastic	5	IN	5.75	10.13	4.00	LB 0.8
			CM	14.6	25.7	10.2	KG 0.4
GL011-0613*	Glove Box Dispenser - Single - White Coated-Wire	10	IN	5.67	8.16	3.75	LB 0.7
			CM	14.4	20.7	9.5	KG 0.3
GL020-0111	Glove Box Dispenser - Double with Divider - Clear PETG Plastic	8	IN	11.38	10.13	4.00	LB 1.2
			CM	28.9	25.7	10.2	KG 0.5
GL020-0212	Glove Box Dispenser - Double with Divider - Quartz Beige ABS Plastic	6	IN	11.38	10.13	4.00	LB 1.2
			CM	28.9	25.7	10.2	KG 0.5
GL020-0223	Glove Box Dispenser - Double with Divider - Maple Fauxwood ABS Plastic	5	IN	11.38	10.13	4.00	LB 1.2
			CM	28.9	25.7	10.2	KG 0.5
GL020-0233	Glove Box Dispenser - Double with Divider - Cherry Fauxwood ABS Plastic	5, 17	IN	11.38	10.13	4.00	LB 1.2
			CM	28.9	25.7	10.2	KG 0.5
GL022-0613*	Glove Box Dispenser - Double - White Coated-Wire	10	IN	10.97	8.16	3.75	LB 1.0
			CM	27.9	20.7	9.5	KG 0.4
GL030-0223	Glove Box Dispenser - Triple with Dividers - Maple Fauxwood ABS Plastic	5, 17, 19	IN	17.00	10.13	4.00	LB 1.4
			CM	43.2	25.7	10.2	KG 0.6

*IMPORTED

Part Number	Product Name	Page	Unit	W (L)	H	D	Product Weight	
GL030-0233	Glove Box Dispenser - Triple with Dividers - Cherry Fauxwood ABS Plastic	5	IN	17.00	10.13	4.00	LB	1.4
			CM	43.2	25.7	10.2	KG	0.6
GL033-0613*	Glove Box Dispenser - Triple - White Coated-Wire	10	IN	16.32	8.16	3.75	LB	1.3
			CM	41.5	20.7	9.5	KG	0.6
GL040-0111	Glove Box Dispenser - Quad with Dividers - Clear PETG Plastic	8	IN	22.63	10.13	4.00	LB	1.9
			CM	57.5	25.7	10.2	KG	0.8
GL040-0212	Glove Box Dispenser - Quad with Dividers - Quartz ABS Plastic	6	IN	22.63	10.13	4.00	LB	1.9
			CM	57.5	25.7	10.2	KG	0.8
GL040-0223	Glove Box Dispenser - Quad with Dividers - Maple Fauxwood ABS Plastic	5	IN	22.63	10.13	4.00	LB	1.9
			CM	57.5	25.7	10.2	KG	0.8
GL040-0233	Glove Box Dispenser - Quad with Dividers - Cherry Fauxwood ABS Plastic	5, 17	IN	22.63	10.13	4.00	LB	1.9
			CM	57.5	25.7	10.2	KG	0.8
GL044-0613*	Glove Box Dispenser - Quad - White Coated-Wire	10	IN	21.67	8.16	3.75	LB	1.6
			CM	55.0	20.7	9.5	KG	0.7
GL100-0212	Glove Box Dispenser - Single with Flexible Springs - Quartz Beige ABS Plastic	6	IN	5.84	10.11	4.22	LB	0.7
			CM	14.8	25.7	10.7	KG	0.3
GL100-1214	Glove Box Dispenser - Single with Flexible Springs - Semi-Transparent Polycarbonate Plastic	8	IN	5.84	10.11	4.22	LB	0.7
			CM	14.8	25.7	10.7	KG	0.3
GL102-0111	Glove Box Dispenser - Single - Food Service - Narrow - Clear PETG Plastic	Not Pictured	IN	5.08	9.10	2.95	LB	0.5
			CM	12.9	23.1	7.5	KG	0.2
GL102-0300	Glove Box Dispenser - Single - Food Service - Narrow - Stainless Steel	12	IN	4.95	9.04	2.82	LB	1.2
			CM	12.6	23.0	7.2	KG	0.5
GL300-0212	Glove Box Dispenser - Triple with Dividers - Quartz Beige ABS Plastic	6	IN	17.08	10.11	4.22	LB	1.4
			CM	43.4	25.7	10.7	KG	0.6
GL300-1214	Glove Box Dispenser - Triple with Dividers - Semi-Transparent Polycarbonate Plastic	8, 15, 18	IN	17.08	10.11	4.22	LB	1.4
			CM	43.4	25.7	10.7	KG	0.6
GP-013	Glove Box Dispenser - Single with Flexible Spring - Clear PETG Plastic	10	IN	5.70	9.85	3.95	LB	0.7
			CM	14.5	25.0	10.0	KG	0.3
GP-014	Glove Box Dispenser - Double - Clear PETG Plastic	10	IN	10.70	10.10	3.95	LB	0.9
			CM	27.2	25.7	10.0	KG	0.4
GP-015	Glove Box Dispenser - Triple - Clear PETG Plastic	10	IN	15.95	10.10	3.95	LB	1.0
			CM	40.5	25.7	10.0	KG	0.4
GP-020	Glove Box Dispenser - Single - Large Capacity with Flexible Spring - Clear PETG Plastic	Not Pictured	IN	6.64	10.03	4.01	LB	0.9
			CM	16.9	25.5	10.2	KG	0.4
GP-061	Glove Box Dispenser - Quad - Clear PETG Plastic	10	IN	22.45	10.03	3.88	LB	1.2
			CM	57.0	25.5	9.9	KG	0.5
GP-071	Glove Box Dispenser - Single - Narrow - Clear PETG Plastic	Not Pictured	IN	5.70	9.85	2.95	LB	0.7
			CM	14.5	25.0	7.5	KG	0.3
GP-072	Glove Box Dispenser - Double - Narrow - Clear PETG Plastic	Not Pictured	IN	10.70	10.10	2.95	LB	0.8
			CM	27.2	25.7	7.5	KG	0.3
GP-073	Glove Box Dispenser - Triple - Narrow - Clear PETG Plastic	12	IN	15.95	10.10	2.95	LB	0.9
			CM	40.5	25.7	7.5	KG	0.4
GP-106	Glove Box Dispenser - Double - Space Saver - Clear PETG Plastic	Not Pictured	IN	5.70	20.10	4.08	LB	1.4
			CM	14.5	51.1	10.4	KG	0.6
GP-107	Glove Box Dispenser - Triple - Space Saver - Clear PETG Plastic	13	IN	5.50	30.11	3.94	LB	2.0
			CM	14.0	76.5	10.0	KG	0.9
GP-310	Glove Box Dispenser - Single - Clear PETG Plastic	12	IN	11.20	4.85	3.70	LB	0.7
			CM	28.4	12.3	9.4	KG	0.3

*IMPORTED

Part Number	Product Name	Page	Unit	W (L)	H	D	Product Weight	
GP-320	Glove Box Dispenser - Double - Clear PETG Plastic	12	IN	11.20	9.60	3.70	LB	1.2
			CM	28.4	24.4	9.4	KG	0.5
GP-330	Glove Box Dispenser - Triple - Clear PETG Plastic	12	IN	11.20	14.35	3.70	LB	1.7
			CM	28.4	36.4	9.4	KG	0.7
GP-340	Glove Box Dispenser - Quad - Clear PETG Plastic	12	IN	11.20	19.10	3.70	LB	2.3
			CM	28.4	48.5	9.4	KG	1.0
GS-004	Glove Box Dispenser - Single with Flexible Spring - Stainless Steel	6, 11	IN	5.60	9.96	3.80	LB	1.4
			CM	14.2	25.3	9.7	KG	0.6
GS-005	Glove Box Dispenser - Double - Stainless Steel	11	IN	10.56	10.04	3.82	LB	1.4
			CM	26.8	25.5	9.7	KG	0.6
GS-006	Glove Box Dispenser - Triple - Stainless Steel	11	IN	15.82	10.04	3.79	LB	1.8
			CM	40.2	25.5	9.6	KG	0.8
GS-060	Glove Box Dispenser - Quad - Stainless Steel	11	IN	22.32	9.99	3.81	LB	2.4
			CM	56.7	25.4	9.7	KG	1.1
GS-073	Glove Box Dispenser - Single - Large Capacity with Flexible Spring - Stainless Steel	Not Pictured	IN	6.50	9.96	3.80	LB	1.5
			CM	16.5	25.3	9.7	KG	0.7
GS-108	Glove Box Dispenser - Double - Space Saver - Stainless Steel	Not Pictured	IN	5.60	20.03	3.94	LB	2.4
			CM	14.2	50.9	10.0	KG	1.1
GS-109	Glove Box Dispenser - Triple - Space Saver - Stainless Steel	13	IN	5.50	30.04	3.94	LB	3.6
			CM	14.0	76.3	10.0	KG	1.6
GS-122	Glove Box Dispenser - Double with Divider - Stainless Steel	6	IN	10.59	10.03	3.81	LB	1.8
			CM	26.9	25.5	9.7	KG	0.8
GS-123	Glove Box Dispenser - Triple with Dividers - Stainless Steel	6	IN	15.87	10.03	3.81	LB	2.3
			CM	40.3	25.5	9.7	KG	1.0
GS-124	Glove Box Dispenser - Quad with Dividers - Stainless Steel	6	IN	21.16	10.03	3.81	LB	2.4
			CM	53.7	25.5	9.7	KG	1.1
NC001-0512	Bedpan/Urinal Dispenser - Quartz Beige Powder-Coated Aluminum	19	IN	12.33	12.00	4.66	LB	1.9
			CM	31.3	30.5	11.8	KG	0.8
PS004-0111	Protection System - Glove & Bag - Clear PETG Plastic	Not Pictured	IN	10.10	20.40	3.95	LB	1.2
			CM	25.7	51.8	10.0	KG	0.5
PS004-0212	Protection System - Glove & Bag - Quartz Beige ABS Plastic	Not Pictured	IN	10.10	20.40	3.95	LB	1.3
			CM	25.7	51.8	10.0	KG	0.6
PS016-0223	Protection System - Maple Fauxwood ABS Plastic	17	IN	23.38	26.63	4.75	LB	7.8
			CM	59.4	67.6	12.1	KG	3.5
PS016-0233	Protection System - Cherry Fauxwood ABS Plastic	17	IN	23.38	26.63	4.75	LB	7.8
			CM	59.4	67.6	12.1	KG	3.5
RE101-0012	Semi-Recessed PPE Dispensing System - Standard - Quartz Beige Powder-Coated Steel	18	IN	Call for more information			LB	22.4
			CM	Call for more information			KG	10.1
RE301-0012	Semi-Recessed Glove Box Dispenser - Triple - Quartz Beige Powder-Coated Steel	15	IN	Call for more information			LB	9.4
			CM	Call for more information			KG	4.2
RE302-0012	Semi-Recessed Face Mask & Tissue Dispenser - Quartz Beige Powder-Coated Steel	Not Pictured	IN	Call for more information			LB	9.4
			CM	Call for more information			KG	4.2
RE401-0012	Semi-Recessed Face Mask & Glove Dispenser - Quartz Beige Powder-Coated Steel	15	IN	Call for more information			LB	11.8
			CM	Call for more information			KG	5.3
RE404-0012	Semi-Recessed Glove Box Dispenser - Quad - Quartz Beige Powder-Coated Steel	15	IN	Call for more information			LB	11.8
			CM	Call for more information			KG	5.3

*IMPORTED



easy

ORDERING

Ask your distributor for us by name.
Accept no imitations.
There's only one genuine BOWMAN.



order online:
Check out conveniently from
your phone, tablet or computer:
BowmanDispensers.com



**order through your
regular distributor:**
Find a list of our distributors online:
[BowmanDispensers.com/
About-Us/Distributors](http://BowmanDispensers.com/About-Us/Distributors)



order over the phone:
Give us a call with questions
or to place an order:
toll free: 800.962.4660
fax: 360.435.5277

CustomerService@BowmanDispensers.com | Sales@BowmanDispensers.com

industry leading

15 YEAR WARRANTY

By driving the highest manufacturing standards possible and making our products in the USA, BOWMAN stands behind the quality of our dispensers. We provide an *industry leading* 15 year warranty on all aluminum and steel dispensers.



Streaming live concerts to hospitalized kids



BOWMAN is a proud sponsor of the Melodic Caring Project. Learn more about how you can play a part: MelodicCaringProject.org



Proudly made in the USA

BOWMAN Dispensers is a specialized design and development business creating personal protective equipment (PPE) dispensing solutions. Once a healthcare dominated industry, PPE dispensing devices have expanded in application to most commercial markets such as industrial, food service, education and beyond. We are at the forefront of innovative dispenser design across all industries.

Since 1988, with customer collaboration, BOWMAN now offers over 200 unique items in our product line. As a privately held company, our owners are involved in the business every day. BOWMAN is proud to serve as your industry advocate, partnering with you to create safe, organized and efficient work environments.



organize contain comply

ASK YOUR DISTRIBUTOR
FOR BOWMAN PRODUCTS.
ACCEPT NO IMITATIONS.

CONTACT US

call: 800.962.4660 | fax: 360.435.5277

CustomerService@BowmanDispensers.com

www.BowmanDispensers.com

