



BOWMAN®



Dispensers

Organize • Contain • Comply

2018 catalog

PROTECTION SYSTEMS

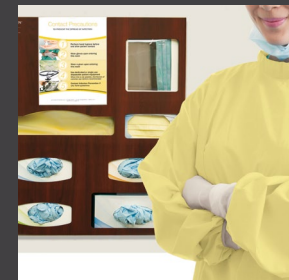
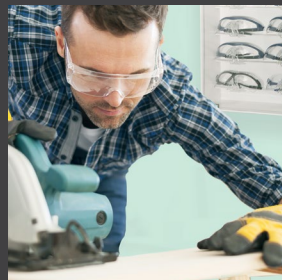

P P E D I S P E N S I N G S O L U T I O N S F O R E V E R Y M A R K E T

adaptable

TO ANY SETTING



Food Service



Business



Laboratory



Industrial



Healthcare



Dental



Construction



Education

- (ABS)** ABS Plastic 02
- (AFP)** ABS Fauxwood Plastic 02
- (ALM)** Aluminum 05
- (CRS)** Cold Rolled Steel 04
- (PET)** PETG Plastic 01

- (PLC)** Polycarbonate Plastic 12
- (STP)** Sintra® Plastic 07
- (STS)** Stainless Steel 03
- (WIR)** Powder-Coated Wire 06

material

- (●)** Bay Gray 29
- (●)** Black 20
- (●)** Cherry 33
- (●)** Maple 23
- (●)** Stainless Steel 00

- (○)** Clear 11
- (○)** Frosted Clear 14
- (○)** Quartz Beige 12
- (○)** White 13, 34

color

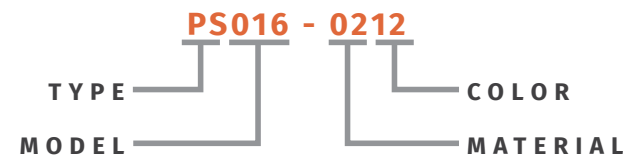

Example: **PS016-0212**
Protection System, Model 016, ABS, Quartz Beige

number

find your solution

- Protection Systems4**
 - Wall Mount & Over the Door5
 - 4" Solutions.....7
 - Recessed.....12
 - Mobile14
 - Infection Prevention.....16
- Signature Series18**
- Build A Room20**
- Construction & Renovation22**
- Index.....24**



learn more:
[BowmanDispensers.com/](http://BowmanDispensers.com/Product-Videos)
Product-Videos

Visit our website for extended material and color information. Colors may vary. Not all colors or materials are available for all dispensers. Use the material codes shown in this catalog as a reference for what a particular dispenser is made from. Custom options are also available.

rethink

YOUR ISOLATION

BOWMAN has Protection System Solutions to fit any space, PPE volume & budget:



Wall Mount



Over the Door



Recessed



Mobile

easy, adaptable,
beautiful & fast



Protection System Solutions from BOWMAN feature:

- Designs with direct input from healthcare professionals
- Highly visible & accessible PPE, allowing for easy restocking
- Universal sizing
- A variety of colors & configurations
- Small, medium & large dispensing capabilities
- Compatibility with BOWMAN Isolation Reference Cards & FREE printable signs to help prevent the spread of HAI's
- Made in the USA



learn more:
[BowmanDispensers.com/
Product-Videos](http://BowmanDispensers.com/Product-Videos)

Wall Mount & Over the Door Protection Systems

- Great for areas where hallway space constraints apply
- Portable or permanent mounting options available
- Standardize PPE location with wall mount units
- Visibility of supplies leads to increased PPE usage and compliance
- Quickly add isolation supplies during an outbreak with temporary door mounts
- Cost effective alternative to isolation carts

easy
& ADAPTABLE

The Best Selling PS016 Protection System

Our proven design can be customized 125 different ways, mounts on doors or walls, and holds most major manufacturers' PPE products.



PS016 isolation kits:
BD601-0012 = PS016-0212 + MP-047
BD602-0012 = PS016-0212 + MP-047 + MB-600
See pages 8 & 10 for details



1 Variety of color & material offerings

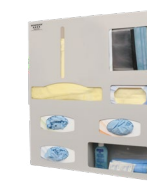

PS016-0512
Aluminum



PS016-0223
Maple Fauxwood



PS016-0233
Cherry Fauxwood



PS016-0212
ABS Plastic



PS016-0300
Stainless Steel



PS016-0111
PETG Plastic

2 Sanitizer mounting area:

- Dial 54564
- Purell 1450-D8
- Steris 2121

3 Universal gown storage:

- Flat pack
- Laundered
- Overhead cover packs
- Thumb loop in boxes
- Thumb loop stacked

4 Adaptable storage area:

- 4th box of gloves
- Boxed face masks
- Miscellaneous supplies
- Miscellaneous wipes



Wall & Over the Door



Double Glove

LD-037 (ABS)

Also available - PS022-0512 (ALM)



Double Gown

PS015-0212 (ABS)

Also available - PS015-0512 (ALM)



Original

LD-007 (ABS)

Also available - PS021-0512 (ALM)



Compact

FM002-0212 (ABS)

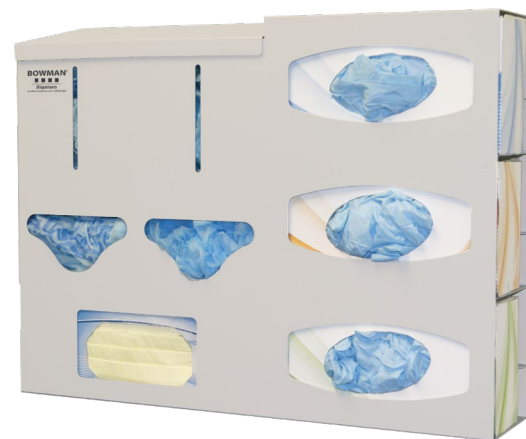

Surgical

PS023-0512 (ALM)

Also available - LP-004 (ABS)

comply

INCH BY INCH



4" Protection System Solutions

- 4 inches deep to accommodate wall protrusion guidelines
- Adaptable to hang on a wall or over the door with a hanger
- Quickly converts to an isolation unit by adding a MP-047 sign holder & free isolation signs from BowmanDispensers.com
- Fits most standard size glove boxes and gowns; due to depth, face masks may need to be removed from box

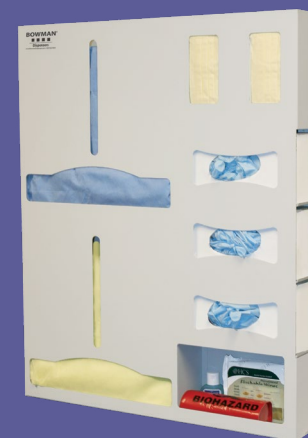

Double Gown

PS415-0512 (ALM) **new product**

4" Wall Extension

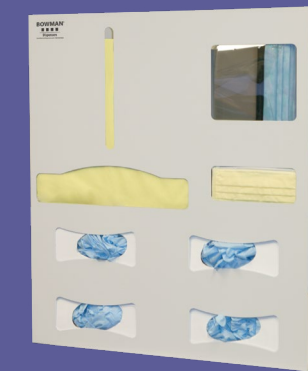

Quad Glove

PS412-0512 (ALM) **new product**

4" Wall Extension

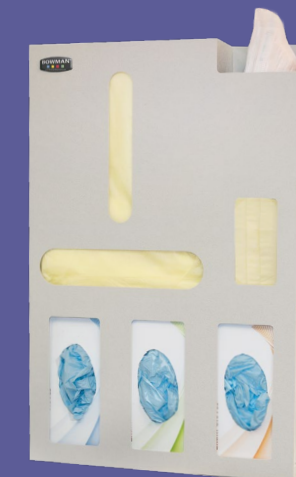

Triple Glove

LD-064 (ABS)

4" Wall Extension
Narrow

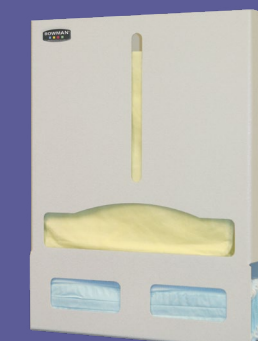

Gown & Earloop

PS426-0212 (ABS) **new product**

4" Wall Extension
Narrow

All consumable items are for demonstration purposes only and are not available for purchase through BOWMAN®

safety

AT ALL TIMES

Place a Wall Mount Protection System outside of each patient room for protection against blood borne pathogens.



isolation

IN A HEART BEAT

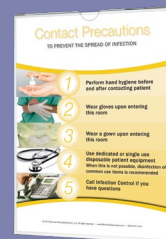

Quickly convert to an Isolation Station by clipping on a Sign Holder.

MP-047 Sign Holders sold separately; free isolation signs are available at BowmanDispensers.com

PS016 isolation kit:
BD601-0012 = PS016-0212 + MP-047



Kit includes Protection System & Sign Holder

wall

MOUNT OPTIONS

Wall Mount Hanger

- Makes isolation easy by permanently mounting a wall hanger outside of each patient room
- When isolation is needed, just hang the Protection System onto the small metal bracket and the room is ready



MB-510 
Hanger - Wall



Direct-to-Wall with Keyholes

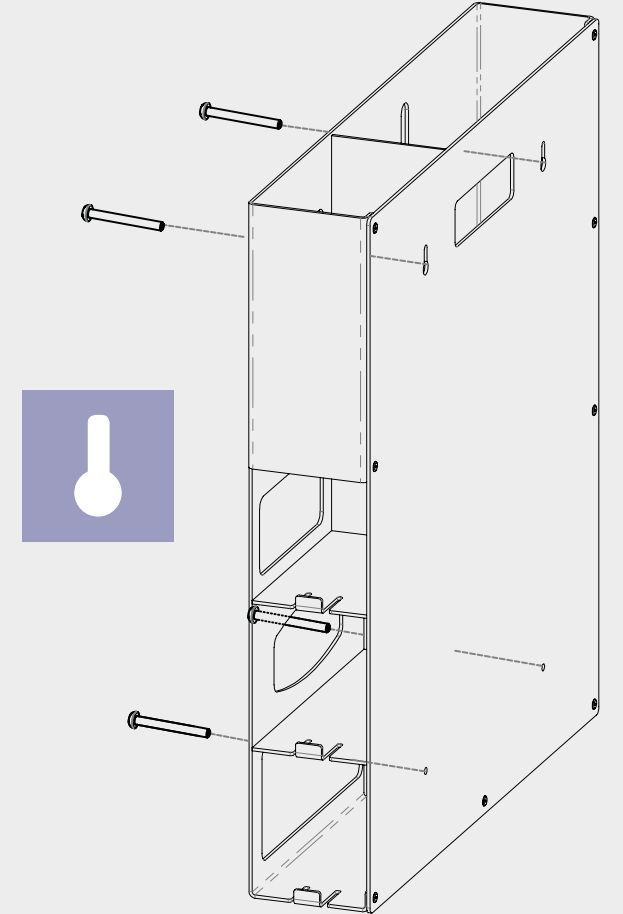

- Permanently mount Protection Systems using keyholes on back, with customer supplied hardware
- Increases compliance by ensuring PPE is consistently available to staff outside of each patient room

door

MOUNT OPTIONS

Traditional Door Hanger



- Convert to an Over the Door Solution by adding a hanger to a door, then adding any Protection System
- Easy to implement—just hang and start using
- Our most popular door hanger for standard sized doors
- Similar style to a wreath hanger
- Quick, cost effective solution, especially during an outbreak

top seller

MB-600 CRS
Hanger - Door

Also available:
MB-601 - for doors taller than 9 ft



PS016 isolation door kit:

BD602-0012 = PS016-0212 + MP-047 + MB-600



Kit includes Protection System, Sign Holder, and Door Hanger



Fire Door Hanger



MB-450 CRS
Hanger - Metal Bracketed Doors

- Double pronged solution
- Holds Protection Systems at adjustable heights to accommodate door hardware on fire doors



Glass Door & Window Hanger



- Holds Protection Systems securely on glass using double sided semi-permanent VHB tape

MB-500 CRS
Hanger - Glass

BEAUTIFULLY
compliant
EXCLUSIVELY
BOWMAN



Recessed Protection Systems



RE101-0012 **new product**
Protection System - Standard
24.36"W x 27.65"H x 4.77"D

Far Left: Partial Open View
Bottom Right: Recessed In wall

Additional Recessed Dispensers listed in Glove Box Dispensers (pg 37), Face Mask Dispensers (pg 38), and Construction (pg 56)



BACKED BY OUR
15 YEAR
WARRANTY

Recessed Protection Systems are a smart choice for high traffic areas, such as hallways or near elevators. Our in-wall solutions avoid wall protrusion rule concerns while keeping necessities organized and at hand.

FEATURING:

- Avoids wall protrusion violations; once installed protrusion is approximately 1 ¼"
- Easy supply standardization
- Separates PPE supplies in a clean and protected environment
- Reduced surface area potentially minimizes risk for contamination
- Visible access to supplies improves PPE donning compliance and restocking
- Improves HCAHPS scores with a sleek, organized and aesthetically pleasing design
- One in-wall well & adjustable shelves
- Keyless locking
- Patent pending

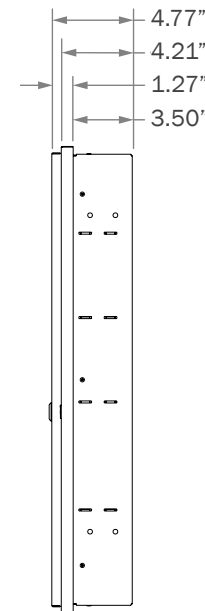

Center Side View
Mounting Specs for
All Recessed Units

- 4.77" - Overall depth to face of door
- 4.21" - Overall depth to front of frame
- 1.27" - Depth of installed wall protrusion
- 3.50" - Recessed depth

Measurements shown are overall external dimensions. For detailed specs, download product datasheets at BowmanDispensers.com.

All consumable items are for demonstration purposes only and are not available for purchase through BOWMAN®



RE201-0012 **new product**
Protection System - Double Gown
27.38"W x 33.33"H x 4.77"D



RE202-0012 **new product**
Protection System - Launderable Gown
27.38"W x 33.33"H x 4.77"D



recessed video:
[BowmanDispensers.com/
Product-Videos](http://BowmanDispensers.com/Product-Videos)

no bending

NO DRAWERS
NO FRUSTRATION



CT030-0000    **new product**
Shown with MP-047 -
Vertical sign holder

The Mobile Protection System from BOWMAN is your high-capacity, no frustration solution for quick and accurate compliance.

FEATURING:

- Easy visibility & instant access to PPE
- Ergonomic design is easy on your back—no bending and no drawers
- Converts to a mobile isolation station by clipping on a MP-047 Sign Holder
- Large storage capacity
- Additional storage area with doors and a removable shelf
- Immediate access to restock ensuring an efficient workflow
- Donning order indicators—an industry first
- PPE sizing indicators
- Clear lid to visualize the products at all times for efficient reloading
- 3 inch, easy roll, locking casters



Donning Process Indicators



Additional Storage Area for PPE Restocking with Removable Shelf

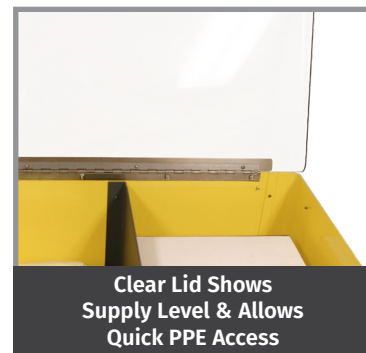

Clear Lid Shows Supply Level & Allows Quick PPE Access



Glove Size Indicators



Organized & Ergonomically Designed



3 Inch Locking Casters



fast

 **mobile video:**
BowmanDispensers.com/
Product-Videos

It All Starts with a Little Card

Arm frontline staff with the tools necessary to isolate potentially infected patients upon arrival.

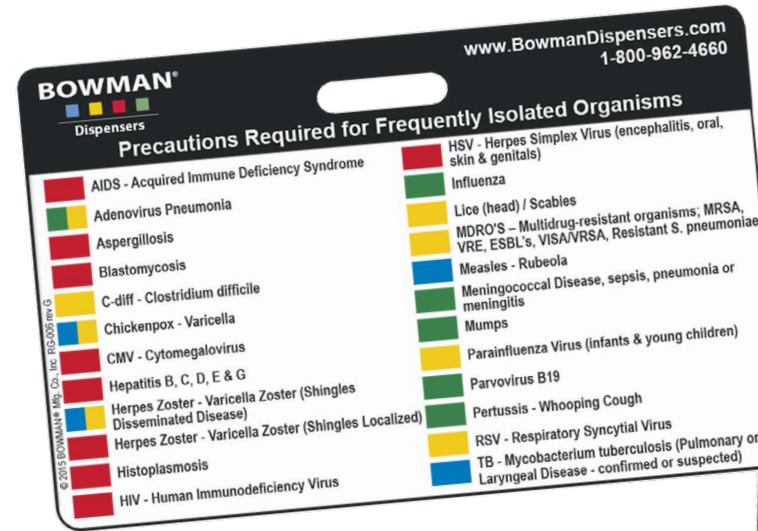

Hand Hygiene Before & After Patient Contact	Standard	Contact	Droplet	Airborne
Clinical Situation	All patients	MDRO's - Resistant organisms; Diarrhea; Draining wounds	Upper Respiratory Infections; including unknown infections prior to organism ID	Tuberculosis - Pulmonary or Laryngeal Disease, confirmed or suspected; Chickenpox or Measles
Room Preference	Private or semi-private	Private. Consult Infection Control (IC) for co-horting	Private. Consult Infection Control (IC) for co-horting. Separate patients by 3 ft	Private. AIR negative airflow, door closed
Wear Gloves	Contact w/ blood, body fluids, or potentially contaminated material	Wear gloves upon entering room	Same as standard precautions	Same as standard precautions
Wear a Mask	Contact w/ blood, body fluids, or potential sprays of respiratory secretions	Same as standard precautions	Wear a mask upon entering room	Wear an N-95 mask or higher level respirator
Wear a Gown	Contact w/ blood, body fluids, or potentially contaminated material	Wear a gown upon entering room	Same as standard precautions	Same as standard precautions

RG-006

Transmission Based Precautions Quick Reference Card - Horizontal
Made of PVC Plastic

Also available as a vertical card - RG-008



learn more:
[BowmanDispensers.com/
Product-Videos](http://BowmanDispensers.com/Product-Videos)

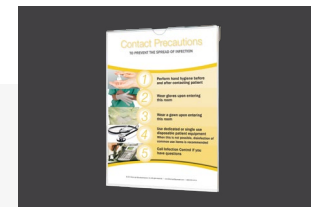
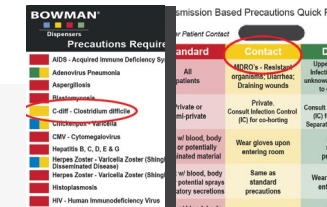
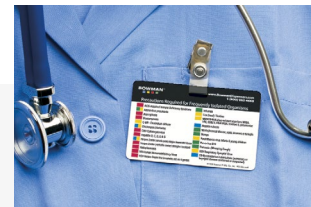

1

Arm Staff with Isolation Reference Cards

RG-006

2

Identify Organism on Card and Match to Isolation Type

3

Print FREE Color-Coded Isolation Sign to Match Isolation Type

4

Place Sign in Clip-On Sign Holder

MP-047

5

Place Sign Holder on Most BOWMAN Protection Systems

PS016-0212 with MP-047

Information based on the Guideline for Isolation Precautions: Preventing Transmission of Infectious Agents in Healthcare Settings. Recommendations of the Healthcare Infection Control Practices Advisory Committee (HICPAC), CDC. <https://www.cdc.gov/infectioncontrol/pdf/guidelines/isolation-guidelines.pdf>

break free

FROM COSTLY VIOLATIONS,
HEALTHCARE ASSOCIATED INFECTIONS
& OUTBREAK INVESTIGATIONS

Separate Clean & Dirty Areas—USE FD-068

Exam Rooms / Clinics / Physicians' Offices

Stop Spreading Germs—USE ED-097

Transportation Services / Nursing Stations /
Waiting Areas / Offices



FD-068 (ABS)
Infection Prevention System



ED-097 (ABS) (PET)
Infection Prevention System
MP-075 Sign Holder included



Signature Series: naturally

SUITED TO YOUR SPACE

Signature Series

FEATURES:

- Natural woodgrain appearance compliments any interior
- All styles shown available in Cherry or Maple Fauxwood
- Visually appealing, upscale option
- Increases customer satisfaction
- Strong and durable
- Easy to clean; stands up to hospital grade cleaners
- Most BOWMAN dispensers can be custom ordered with Signature Series materials; minimum order quantities may apply

Cover Your Cough Kits

Everything you need in one convenient kit.

BD212-0023 (AFP)

Countertop or Wall Mount Station & Sign
Also available in Cherry - BD212-0033



BD111-0033 (AFP)

Freestanding Station, Stand & Sign
Also available in Maple - BD111-0023



Glove Box Dispensers

Three-way keyholes for vertical or horizontal mounting.



GL010-0223 (AFP)

Also available in Cherry - GL010-0233



GL020-0233 (AFP)

Also available in Maple - GL020-0223



GL030-0223 (AFP)

Also available in Cherry - GL030-0233



GL040-0233 (AFP)

Also available in Maple - GL040-0223

Protection Systems

Mount to wall, door or glass: see pages 4-11 for more details.



PS016-0233 (AFP)



PS016-0223 (AFP)

Individual colors may vary | All consumable items are for demonstration purposes only and are not available for purchase through BOWMAN®



Build A Room by BOWMAN



[BuildARoomByBowman.com](https://www.BuildARoomByBowman.com)

bring your vision to life

Build A Room shows you the end result in just a few clicks with a camera and a mouse. Create, save and output an image of your ideal room, like the one shown at right.



plan, design, execute

From taking a photo of the area you want to outfit with dispensers, to arranging them according to your needs, you are in complete control of the whole process.

Build A Room is NEW and exclusive to BOWMAN Dispensers:

- Visually plan out your workflow, organization and storage needs
- See firsthand how dispensers will fit in your space
- Arrange, align, and rearrange until you have the perfect placement
- Try out multiple combinations with no commitment to purchase
- Print and download your final layout
- Saved PDF includes a list of your chosen dispensers for reference

Create your ideal working environment in just a few easy steps at [BuildARoomByBowman.com](https://www.BuildARoomByBowman.com):



Choose the consumable(s) and room(s) that need organization.



Tape an 8 1/2" x 11" piece of paper to the wall and take a photo straight on of the room.



Select your room type in Build A Room and upload your photo.

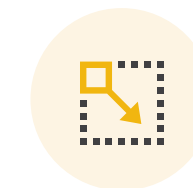

Arrange the yellow square to fill your paper in the photo.



Drag and drop dispensers into your space.



Save your design then print or send your layout to your planning team.

Success is in the details

Integrate PPE Dispensing Solutions into the project planning phase to save space, improve aesthetics and reduce code violations.



value adds FOR EVERY PROJECT

- Recessed, Interior Cabinet, Custom & Stock PPE Dispensing Solutions
- Material options for any budget
- Finish options for any interior
- All products offer best functionality and quality aesthetics
- Strong materials withstand heavy use & hospital grade cleaning products

Get started today: 800-962-4660



free planning tools:
Find our Hospital Dispenser Planning Checklist and more at BowmanDispensers.com



build a room:
Plan and arrange dispensers using a photograph of your space (see pgs 20-21)



learn more:
BowmanDispensers.com/Product-Videos

Recessed Solutions

BEAUTIFULLY COMPLIANT

- Keeps high traffic areas clear & avoids wall protrusion rules
- Variety of layout options for Glove Dispensing, Flu Prep, & Protection Systems
- Available through the BOWMAN Custom Design Program



RE101-0012 (CRS)
Protection System - Standard
24.36"W x 27.65"H x 4.77"D

More recessed options:
Gloves - pg 37
Face Masks - pg 38
Protection Systems - pg 12-13

Interior Cabinet Dispensing

BUILT-IN ESSENTIALS

- Frees up space on countertops and walls with a polished look
- Available for select stock dispensers & any custom designed products



GB-144 (CRS)
Glove Box Dispenser - Single
Unmounted View



GL300-1214 (PLC)
Glove Box Dispenser - Triple with Dividers
Left: Side view; Right: cabinet & inside dental office



Ready-to-Install Stock Designs

EASY OPTIONS

- A variety of colors and materials
- Expedited shipping available for quick turn-around projects
- Some of our best sellers are shown below; browse through the catalog to see a large variety of options



NC001-0512 (ALM)
Bedpan/Urinal
Dispenser



GL030-0223 (AFP)
Glove Box Dispenser
Triple with Dividers

Custom Designs

UNIQUE LOCATION SOLUTIONS

- If you can dream it, we can do it
- Minimum order quantities may apply

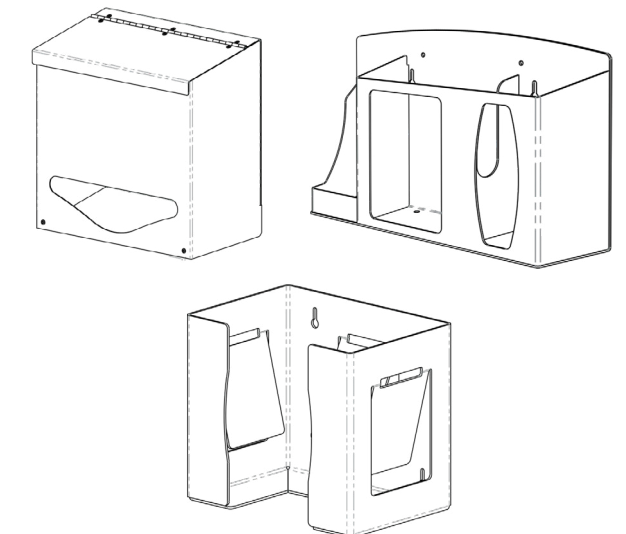

Part Number	Product Name	Page	Unit	W (L)	H	D	Product Weight	
BD601-0012	Protection System Isolation Kit - Includes: PS016-0212, MP-047	5, 8	IN	23.38	26.63	5.38	LB	8.3
			CM	59.4	67.6	13.7	KG	3.8
BD602-0012	Protection System Isolation Kit - Includes: PS016-0212, MB-600, MP-047	5, 10	IN	23.38	36.51	5.40	LB	9.3
			CM	59.4	92.7	13.7	KG	4.2
BD111-0033	Cover Your Cough Compliance Kit with Vertical Sign Holder - Includes: RS001-0233, KS010-0420, MP-070	18	IN	18.00	58.36	18.00	LB	18.8
			CM	45.7	148.2	45.7	KG	8.5
BD212-0023	Cover Your Cough Compliance Kit with Horizontal Sign Holder - Includes: RS001-0223, MP-075	18	IN	17.90	19.80	4.45	LB	3.3
			CM	45.5	50.3	11.3	KG	1.5
CT030-0000	Mobile Protection System - Safety Yellow Powder-Coated Aluminum and Steel, Gray Powder-Coated Aluminum, Brushed Nickel Hardware and Polycarb Plastic Lid	14, 15	IN	26.10	53.15	16.67	LB	75.0
			CM	66.3	135.0	42.3	KG	34.0
ED-097	Infection Prevention System - Quartz Beige ABS Plastic & Clear PETG Plastic Sign Holder	17	IN	15.00	11.38	5.75	LB	1.8
			CM	38.1	28.9	14.6	KG	0.8
FD-068	Infection Prevention System - Quartz Beige ABS Plastic	17	IN	18.50	11.63	4.50	LB	2.1
			CM	47.0	29.5	11.4	KG	0.9
FM002-0212	Face Mask Dispenser - Combo or Protection System - Compact - Quartz Beige ABS Plastic	6	IN	10.63	25.25	5.00	LB	3.5
			CM	27.0	64.1	12.7	KG	1.6
GB-144	Glove Box Dispenser - Single with Flexible Spring - Cabinet Mount - White Powder-Coated Steel	22	IN	5.60	10.00	3.80	LB	1.4
			CM	14.2	25.4	9.7	KG	0.6
GL010-0223	Glove Box Dispenser - Single - Maple Fauxwood ABS Plastic	19	IN	5.75	10.13	4.00	LB	0.8
			CM	14.6	25.7	10.2	KG	0.4
GL020-0233	Glove Box Dispenser - Double with Divider - Cherry Fauxwood ABS Plastic	19	IN	11.38	10.13	4.00	LB	1.2
			CM	28.9	25.7	10.2	KG	0.5
GL030-0223	Glove Box Dispenser - Triple with Dividers - Maple Fauxwood ABS Plastic	19, 23	IN	17.00	10.13	4.00	LB	1.4
			CM	43.2	25.7	10.2	KG	0.6
GL040-0233	Glove Box Dispenser - Quad with Dividers - Cherry Fauxwood ABS Plastic	19	IN	22.63	10.13	4.00	LB	1.9
			CM	57.5	25.7	10.2	KG	0.8
GL300-1214	Glove Box Dispenser - Triple with Dividers - Semi-Transparent Polycarbonate Plastic	22	IN	17.08	10.11	4.22	LB	1.4
			CM	43.4	25.7	10.7	KG	0.6
LD-007	Protection System - Quartz Beige ABS Plastic (Aluminum Version PS021-0512)	6	IN	16.63	25.25	4.50	LB	3.9
			CM	42.2	64.1	11.4	KG	1.7
LD-037	Protection System - Quartz Beige ABS Plastic (Aluminum Version PS022-0512)	6	IN	23.50	20.80	4.75	LB	5.6
			CM	59.7	52.8	12.1	KG	2.5
LD-064	Protection System - 4" Deep - Quartz Beige ABS Plastic	7	IN	16.75	25.63	4.00	LB	3.7
			CM	42.5	65.1	10.2	KG	1.7
LD-070	Protection System - Quartz Beige ABS Plastic	<i>Not Pictured</i>	IN	20.05	25.25	4.75	LB	4.3
			CM	50.9	64.1	12.1	KG	2.0
LP-004	Protection System - Surgical - Quartz Beige ABS Plastic & Clear PETG Plastic (Aluminum Version PS023-0512)	<i>Not Pictured</i>	IN	22.15	19.68	4.88	LB	4.8
			CM	56.3	50.0	12.4	KG	2.2
MB-450	Hanger - Metal Bracketed Fire Door - Quartz Beige Powder-Coated Steel	11	IN	26.14	29.49	2.92	LB	2.5
			CM	66.4	74.9	7.4	KG	1.1
MB-500	Hanger - Glass Door - Quartz Beige Powder-Coated Steel with Semi-Permanent VHB Tape	11	IN	22.00	4.62	0.56	LB	1.0
			CM	55.9	11.7	1.4	KG	0.4
MB-510	Hanger - Wall - Quartz Beige Powder-Coated Steel	9	IN	5.50	2.62	0.56	LB	0.2
			CM	14.0	6.7	1.4	KG	0.1
MB-600	Hanger - Door - Standard - Quartz Beige Powder-Coated Steel	10	IN	5.50	12.13	2.50	LB	1.1
			CM	14.0	30.8	6.4	KG	0.5
MB-601	Hanger - Door - Long - Quartz Beige Powder-Coated Steel	10	IN	5.50	19.00	2.50	LB	1.4
			CM	14.0	48.3	6.4	KG	0.6
MD-100	Dental Organizer - Quartz Beige ABS Plastic & Clear PETG Plastic	53	IN	17.61	23.50	5.08	LB	4.4
			CM	44.7	59.7	12.9	KG	2.0
MP-015	Caddy Dispenser - Clip-On - Clear PETG Plastic	<i>Not Pictured</i>	IN	6.20	7.33	6.65	LB	0.9
			CM	15.7	18.6	16.9	KG	0.4

Part Number	Product Name	Page	Unit	W (L)	H	D	Product Weight	
MP-047	Sign Holder - Clip-On - Clear PETG Plastic	8, 10, 15	IN	8.50	11.19	0.63	LB	0.9
			CM	21.6	28.4	1.6	KG	0.4
NC001-0512	Bedpan/Urinal Dispenser - Quartz Beige Powder-Coated Aluminum	23	IN	12.33	12.00	4.66	LB	1.9
			CM	31.3	30.5	11.8	KG	0.8
PS004-0111	Protection System - Glove & Bag - Clear PETG Plastic	<i>Not Pictured</i>	IN	10.10	20.40	3.95	LB	1.2
			CM	25.7	51.8	10.0	KG	0.5
PS004-0212	Protection System - Glove & Bag - Quartz Beige ABS Plastic	<i>Not Pictured</i>	IN	10.10	20.40	3.95	LB	1.3
			CM	25.7	51.8	10.0	KG	0.6
PS012-0512	Protection System - Quad Glove - Quartz Beige Powder-Coated Aluminum	<i>Not Pictured</i>	IN	22.75	25.63	4.58	LB	7.3
			CM	57.8	65.1	11.6	KG	3.3
PS014-0212	Protection System - Gloveless - Quartz Beige ABS Plastic	<i>Not Pictured</i>	IN	23.38	14.98	4.75	LB	4.2
			CM	59.4	38.0	12.1	KG	1.9
PS015-0212	Protection System - Double Gown - Quartz Beige ABS Plastic	6	IN	25.15	30.75	4.75	LB	9.4
			CM	63.9	78.1	12.1	KG	4.3
PS015-0512	Protection System - Double Gown - Quartz Beige Powder-Coated Aluminum	6	IN	25.05	30.75	4.65	LB	11.0
			CM	63.6	78.1	11.8	KG	5.0
PS016-0111	Protection System - Clear PETG Plastic	5	IN	23.50	26.55	4.75	LB	3.1
			CM	59.4	67.6	12.1	KG	1.4
PS016-0212	Protection System - Quartz Beige ABS Plastic	5, 8, 10	IN	23.38	26.63	4.75	LB	7.7
			CM	59.4	67.6	12.1	KG	3.5
PS016-0223	Protection System - Maple Fauxwood ABS Plastic	5, 19	IN	23.38	26.63	4.75	LB	7.8
			CM	59.4	67.6	12.1	KG	3.5
PS016-0233	Protection System - Cherry Fauxwood ABS Plastic	5, 19	IN	23.38	26.63	4.75	LB	7.8
			CM	59.4	67.6	12.1	KG	3.5
PS016-0300	Protection System - Stainless Steel	5	IN	22.75	25.63	4.52	LB	13.2
			CM	57.8	65.1	11.5	KG	6.0
PS016-0512	Protection System - Quartz Beige Powder-Coated Aluminum	5	IN	22.75	25.63	4.58	LB	7.6
			CM	57.8	65.1	11.6	KG	3.4
PS017-0212	Protection System - Surgical - Clear PETG Plastic & Quartz Beige ABS Plastic	<i>Not Pictured</i>	IN	25.00	30.19	6.75	LB	11.7
			CM	63.5	76.7	17.1	KG	5.3
PS021-0512	Protection System - Quartz Beige Powder-Coated Aluminum (ABS Version LD-007)	6	IN	16.48	25.18	4.35	LB	5.9
			CM	41.8	63.9	11.0	KG	2.7
PS022-0512	Protection System - Quartz Beige Powder-Coated Aluminum (ABS Version LD-037)	6	IN	22.75	20.23	4.58	LB	6.1
			CM	57.8	51.4	11.6	KG	2.7
PS023-0512	Protection System - Surgical - Quartz Beige Powder-Coated Aluminum (ABS/PETG Version LP-004)	6	IN	22.10	16.53	4.76	LB	6.6
			CM	56.1	42.0	12.1	KG	3.0
PS026-0212	Surgical Apparel Organizer - Clear PETG Plastic and Quartz Beige ABS Plastic	<i>Not Pictured</i>	IN	12.25	30.78	6.50	LB	6.2
			CM	31.1	78.2	16.5	KG	2.8
PS412-0512	Protection System - Quad Glove - 4" Deep - Quartz Beige Powder-Coated Aluminum	7	IN	22.75	25.63	4.00	LB	7.0
			CM	57.8	65.1	10.2	KG	3.2
PS415-0512	Protection System - Double Gown - 4" Deep - Quartz Beige Powder-Coated Aluminum	7	IN	25.05	30.69	4.00	LB	9.8
			CM	63.6	78.0	10.2	KG	4.4
PS426-0212	Protection System - Gloveless - 4" Deep - Quartz Beige ABS Plastic	7	IN	15.00	19.75	4.00	LB	3.0
			CM	38.1	50.2	10.2	KG	1.4
RE101-0012	Semi-Recessed PPE Dispensing System - Standard - Quartz Beige Powder-Coated Steel	12, 13, 22	IN	<i>Call for more information</i>			LB	22.4
			CM	<i>Call for more information</i>			KG	10.1
RE201-0012	Semi-Recessed Protection System - Double Gown - Quartz Beige Powder-Coated Steel	13	IN	<i>Call for more information</i>			LB	30.2
			CM	<i>Call for more information</i>			KG	13.7
RE202-0012	Semi-Recessed Protection System - Launderable Gown - Quartz Beige Powder-Coated Steel	13	IN	<i>Call for more information</i>			LB	34.2
			CM	<i>Call for more information</i>			KG	15.5
RG-006	Quick Reference Card for Transmission Based Precautions - Horizontal - PVC Plastic	16	IN	3.38	2.13	0.06	LB	0.0
			CM	8.6	5.4	0.2	KG	0.0
RG-008	Quick Reference Card for Transmission Based Precautions - Vertical - PVC Plastic	16	IN	2.13	3.38	0.06	LB	0.0
			CM	5.4	8.6	0.2	KG	0.0



easy

ORDERING

Ask your distributor for us by name.
Accept no imitations.
There's only one genuine BOWMAN.

industry leading

15 YEAR WARRANTY

By driving the highest manufacturing standards possible and making our products in the USA, BOWMAN stands behind the quality of our dispensers. We provide an *industry leading* 15 year warranty on all aluminum and steel dispensers.



Streaming live concerts to hospitalized kids



BOWMAN is a proud sponsor of the Melodic Caring Project. Learn more about how you can play a part: MelodicCaringProject.org



order online:
Check out conveniently from your phone, tablet or computer:
BowmanDispensers.com



order through your regular distributor:
Find a list of our distributors online:
BowmanDispensers.com/About-Us/Distributors



order over the phone:
Give us a call with questions or to place an order:
toll free: 800.962.4660
fax: 360.435.5277

CustomerService@BowmanDispensers.com | Sales@BowmanDispensers.com



Proudly made in the USA

BOWMAN Dispensers is a specialized design and development business creating personal protective equipment (PPE) dispensing solutions. Once a healthcare dominated industry, PPE dispensing devices have expanded in application to most commercial markets such as industrial, food service, education and beyond. We are at the forefront of innovative dispenser design across all industries.

Since 1988, with customer collaboration, BOWMAN now offers over 200 unique items in our product line. As a privately held company, our owners are involved in the business every day. BOWMAN is proud to serve as your industry advocate, partnering with you to create safe, organized and efficient work environments.

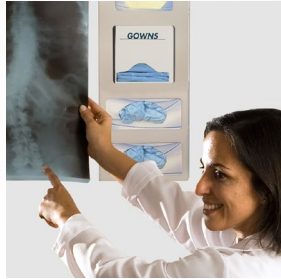

organize contain comply

ASK YOUR DISTRIBUTOR
FOR BOWMAN PRODUCTS.
ACCEPT NO IMITATIONS.

CONTACT US

call: 800.962.4660 | fax: 360.435.5277

CustomerService@BowmanDispensers.com

www.BowmanDispensers.com

