

# QA4™

## Mobile Surgery System

The complete multi-purpose solution for transport, treatment and recovery



**AneticAid**

# QA4 MOBILE SURGERY SYSTEM

Whether for Day / Ambulatory Surgery or Mainstream Theatre, the QA4 is the perfect combination of transport trolley and operating table.



## TRANSPORT TREATMENT RECOVERY



### Moving and Handling

Zero transfers mean risk is minimised for patient and practitioner alike: from the ward, through anaesthetics, to the surgical procedure, and finally to first and second recovery

### Infection Control

A single platform for the entire patient journey, combined with easy-to-clean materials with a range of antibacterial and microbial properties, reduces the chance of cross infection



Combining industry knowledge with innovative technology



Designed and produced at our UK manufacturing facility using the latest engineering techniques



Manufacturer, designer and supplier of high quality medical equipment around the world



Unique manufacturer-backed Lifetime Warranty Scheme

# QA4 MOBILE SURGERY SYSTEM



- Electrically powered functions
- Superior surgical access
- Traversing patient platform
- 100% 'C' arm access
- Lateral tilt
- 250kg weight capacity

## QA4™ Powered Mobile Surgery System

With remotely-activated powered functions, the QA4 Powered Mobile Surgery System offers full 'C' arm coverage, superior surgical access and exceptional stability.



## QA4™ Mobile Surgery System

Excellent manoeuvrability and easy-to-use hand operated functions make the manually operated QA4 Mobile Surgery System a cost effective option.

- Mechanically powered functions
- Increased surgical access
- Supremely light weight and manoeuvrable
- 75% 'C' Arm access
- Cost effective solution
- 160kg weight capacity



DESIGN & INNOVATION



MADE IN THE UK



GLOBAL DISTRIBUTION

Adaptable, versatile, multi-disciplinary

# STANDARD FEATURES

**QA4™**  
Powered Mobile Surgery System

**QA4™**  
Mobile Surgery System

The QA4 Mobile Surgery System is both patient trolley and operating table: a total solution for modern day treatment centres and regular theatres alike.

## Removable articulating headrest

Easily swapped for specialist versions such as the ophthalmics headrest



## Removable rotating side rails

Providing safety for transport, but removable for maximum surgical access

## Press on / Press off 5th wheel steer

Unique mechanism ensures maximum manoeuvrability and easily guided by one person



## Infection control

Smooth moulded surfaces and acrylic capped vac formings enclose trolley mechanics to minimise dirt traps. Anti-bacterial properties and innovative design for easy cleaning



## Removable adjustable height transfusion / infusion stand

Innovative quick release safety locking mechanism



## K8 pressure care mattress

Manufactured from temperature-sensitive gel feel foam that moulds to the patient's body shape, relieving pressure by distributing the load as evenly as possible. Outer material is anti-microbial, water resistant, vapour permeable and latex free



## Removable light weight leg section

Offering maximum surgical access for gynae and urology procedures



## Simultaneous braking low rolling resistance twin wheel castors

Polyurethane tyres offer low rolling resistance for high manoeuvrability: 150mm castors fitted as standard

## O<sub>2</sub> Cylinder trough

Side loading for ease of access, suitable for wide range of cylinder options including E or CD

A unique combination of manoeuvrability and stability



DESIGN & INNOVATION



MADE IN THE UK



GLOBAL DISTRIBUTION

# POWERED FEATURES

**QA4™**  
Powered Mobile Surgery System

**QA4™**  
Mobile Surgery System

Top of the range, the QA4 Powered Mobile Surgery System is ideal for many surgical procedures.

With five remotely-activated powered functions – raise and lower, back rest, traversing top, lateral tilt and Trendelenburg – the trolley offers full 'C' arm coverage and superior surgical access. It also offers exceptional stability with a patient weight capacity of 250kg.



Removable remote handset



PATIENT WEIGHT CAPACITY

Patient platform height raise and lower

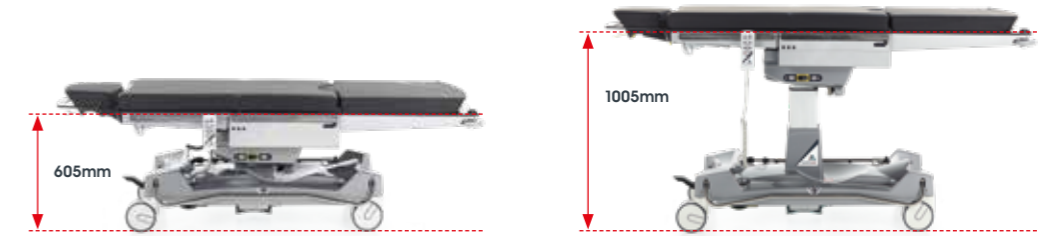

Trendelenburg 20° / Reverse Trendelenburg 12°



Backrest 0 to 65°



Head-end / Foot-end Traversing platform



Lateral tilt + - 12°



SPECIFICATIONS		Code: 21300	
Minimum height	*605mm	Mattress width	600mm
Maximum height	*1005mm	Mattress depth	75mm
Overall length	2100mm	Trendelenburg	20°
Overall width	800mm	Reverse Trendelenburg	12°
Castor diameter	150mm	Lateral tilt	±12°
Weight	160kg	Backrest articulation	0 to 65°
Mattress length	2040mm	Headrest articulation	+25 / -30°

\*NOTE: Measurement from floor to platform top excluding mattress



Effortless positioning at the touch of a button

# MANUAL FEATURES

A cost effective option, the QA4 Mobile Surgery System combines excellent manoeuvrability and simple hand operated functions.

The trolley features both sophisticated hydraulics and gas-assisted pump technology to make the manual functions (raising and lowering the trolley platform and the backrest and placing the trolley in Trendelenburg) as easy as possible for the practitioner.



Trendelenburg handle



160 kg  
PATIENT WEIGHT CAPACITY

QA4™  
Powered Mobile Surgery System

QA4™  
Mobile Surgery System

Trolley platform – hydraulic pump action raise and lower



Trendelenburg: hydraulic damper assisted



Backrest 0 to 80°



Easy mount and dismount from platform



SPECIFICATIONS		Code: 21310	
Minimum height	*575mm	Mattress length	2040mm
Maximum height	*935mm	Mattress width	600mm
Overall length	2100mm	Mattress depth	75mm
Overall width	835mm	Trendelenburg	20°
Castor diameter	150mm	Backrest articulation	0 to 80°
Weight	127kg	Headrest articulation	+25 / -30°

\*NOTE: Measurement from floor to platform top excluding mattress

Hydraulic and gas-assisted pump technology – excellent manoeuvrability



DESIGN & INNOVATION



MADE IN THE UK



GLOBAL DISTRIBUTION

# QA4 MOBILE SURGERY SYSTEM

Available in powered and manual versions, the versatility and superior surgical access of the QA4 Mobile Surgery System make it ideal for a wide range of procedures including general surgery, gynaecology, urology, endoscopy, ophthalmics, dental and ENT.

# SURGICAL VERSATILITY

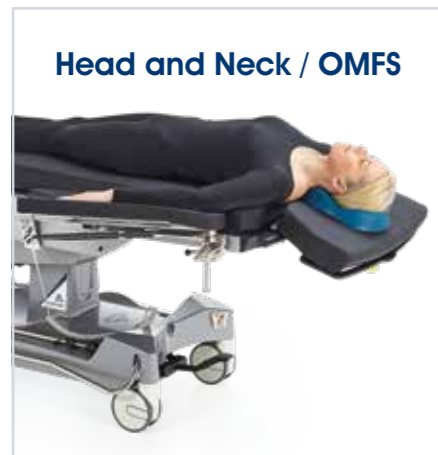

Standard articulating head section or ergonomically designed dual-articulating head section for movement in three different planes

## Breast surgery

Can be fitted with Reison arm supports for superior positioning and stability



## General surgery

Variable height, Trendelenburg and Reverse Trendelenburg positioning, PLUS lateral tilt makes the QA4 Powered model ideal for laparoscopic procedures such as cholecystectomy (gall bladder removal)



DESIGN & INNOVATION



MADE IN THE UK



GLOBAL DISTRIBUTION

Supports a wide range of surgical specialisms

# QA4 MOBILE SURGERY SYSTEM

# SURGICAL VERSATILITY

Mobile Surgery Systems are increasingly being used for a wide range of orthopaedic procedures. The QA4 can be fitted with a variety of attachments including arm tables, lateral and pelvic supports as well as specialist attachments for knee and shoulder arthroscopy.



Attachments are available for lateral, supine and prone positioning

## Knee arthroscopy or procedures

Standard leg section removed making way for specialist leg supports such as the Knee Stabiliser, available in our Operating Table Accessory range



## C-arm

The QA4's platform traverses to both head and foot ends, providing comprehensive C-arm access and we also offer a Retrograde Extension accessory for ERCP retrograde tomography



## Shoulder arthroscopy or procedures

Complete surgical access with shoulder suspension system – or specialist shoulder attachment with back support and headpiece to secure the patient's airway



Specialist attachments for orthopaedic surgeries



DESIGN & INNOVATION



MADE IN THE UK



GLOBAL DISTRIBUTION



# QA4 MOBILE SURGERY SYSTEM

# BUILD OPTIONS



## Side Bar

Description	Code
Side Bar - EU - 25 x 10mm	22315



## Headrest Full Width

Description	Code
Headrest - Full Width Articulating - with K8 Pressure Care Mattress	22322
Headrest - Full Width Articulating - with UK Side Bar and K8 Pressure Care Mattress	22330
Headrest - Full Width Articulating - with EU Side Bar and K8 Pressure Care Mattress	22331



## Headrest - Dual-articulating

Description	Code
Headrest - Dual-articulating Head Positioner - with Shaped Cushion and Neck Plate Pad	22325

## Department Identification



Description	Code
Department Identification - Vinyl Transfer Lettering	21175

## Oxygen Cylinder Bracket



Description	Code
Oxygen Cylinder Bracket - for CD Sized Cylinder	21393

## Paper Roll Holder



Description	Code
Paper Roll Holder (up to 620mm wide) *Not suitable for use with Leg Section - Articulating variants	21159

## Model specific build option

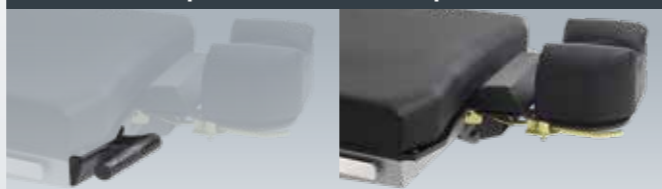

## QA4™ Powered Mobile Surgery System

Description	Code
Backrest Board - Pushing Handles Removed	22345

## Customisation

Build Options (which must be specified at the time of ordering) enable you to customise your QA4 with special features – including swapping standard Headrests and Leg Sections for those designed for particular surgical specialisms.



## Leg Section - Articulating

Description	Code
Leg Section - Articulating	22355



## Leg Section - Articulating with Side Bar

Description	Code
Leg Section - Articulating - with 105mm UK Side Bar	22353
Leg Section - Articulating - with 105mm EU Side Bar	22354



## Leg Section - Standard with Side Bar

Description	Code
Leg Section - Standard Light Weight - with Full Length UK Side Bar	22357
Leg Section - Standard Light Weight - with Full Length EU Side Bar	22358

Build options must be specified at the time of ordering



DESIGN & INNOVATION

MADE IN THE UK

GLOBAL DISTRIBUTION

# QA4 MOBILE SURGERY SYSTEM

# OPTIONAL EXTRAS



**Headrest  
Full Width**

Description	Code
Headrest - Full Width Articulating - with K8 Pressure Care Mattress	21322
Headrest - Full Width Articulating - with UK Side Bar and K8 Pressure Care Mattress	21322-UK
Headrest - Full Width Articulating - with EU Side Bar and K8 Pressure Care Mattress	21322-EU



**Headrest –  
Dual-articulating**

Description	Code
Headrest - Dual-articulating Head Positioner - with Shaped Cushion and Neck Plate Pad	21325

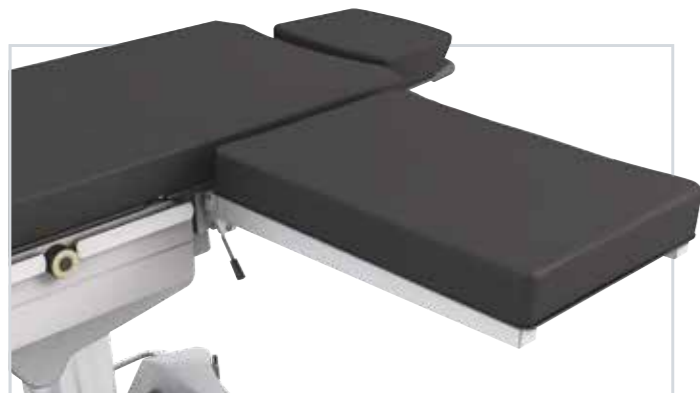

**Extended Arm Table**

Description	Code
Extended Arm Table - Lightweight - Radiolucent - L685mm x W450mm with D75mm Pad	10233



**Easy Armboard**

Description	Code
Easy Armboard - Lift-to-Position - for UK Side Bar - 75mm Pad	10775
Easy Armboard - Lift-to-Position - for EU Side Bar - 75mm Pad	10774



**Armboard**

Description	Code
Armboard - Rotatable (10-387) - with Rotating Clamp - for UK Side Bar	10400-UK
Armboard - Rotatable (10-387) - with Rotating Clamp - for EU Side Bar	10400-EU
Armboard Cushion / Pad (10-382-H) - Medisoft (Viscoelastic) - Tapered Bottom with Guttered Top Surface - 40mm*	10415-B1

\*Required when ordering 10400-UK or 10400-EU - Armboard - Rotatable

## Extending Scope

Specialist Headrests and Leg Sections, along with a wide range of other Operating Table Accessories can be purchased at any time to extend the range of surgical procedures that can be performed on a QA4.



**Leg Section –  
Articulating**

Description	Code
Leg Section - Articulating	21355



**Leg Section –  
Articulating  
with Side Bar**

Description	Code
Leg Section - Articulating - with 105mm UK Side Bar	21353
Leg Section - Articulating - with 105mm EU Side Bar	21354



**Leg Section –  
Standard with Side Bar**

Description	Code
Leg Section - Standard Light Weight - with Full Length UK Side Bar	21357
Leg Section - Standard Light Weight - with Full Length EU Side Bar	21358

Wide range of extra items to complement any QA4 Mobile Surgery System



DESIGN & INNOVATION



MADE IN THE UK



GLOBAL DISTRIBUTION

# QA4 MOBILE SURGERY SYSTEM

## Lift-Assist™ Lithotomy Stirrups



Accessory Clamps  
supplied separately unless  
otherwise stated

### Quick reference guide:

STANDARD	PATIENT WEIGHT CAPACITY
Handle type: <b>Twist Grip</b>	159 kg
Boot type: <b>Standard</b>	
Lithotomy range: <b>+84° / -33°</b>	
Abuction range: <b>+25° / -9°</b>	
FINNED ELITE	PATIENT WEIGHT CAPACITY
Handle type: <b>Squeeze Grip</b>	227 kg
Boot type: <b>Protective Fin</b>	
Lithotomy range: <b>+84° / -33°</b>	
Abuction range: <b>+25° / -9°</b>	
HEAVY DUTY	PATIENT WEIGHT CAPACITY
Handle type: <b>Twist Grip</b>	327 kg
Boot type: <b>Enlarged Standard</b>	
Lithotomy range: <b>+84° / -33°</b>	
Abuction range: <b>+25° / -9°</b>	

Description	Code
Lift-Assist™ Lithotomy Stirrups - Standard - includes Boot-pads - Max. Patient Weight @159kg / 25 Stone	10755
Lift-Assist™ Lithotomy Stirrups - Finned Elite - includes Boot-pads - Max. Patient Weight @227kg / 36 Stone	10757
Lift-Assist™ Lithotomy Stirrups - Heavy Duty - includes Boot-pads - Max Patient Weight @327kg / 52 Stone	10758

## Knee Crutch Stirrups



Description	Code
Simplicity™ Knee Crutch Stirrups - Complete with Boot Pads (Supplied without Clamps) Pair	10765

## Perineal Instrument Tray



Description	Code
Perineal Instrument Tray, Multi-pin	10235

## Retrograde Extension



Description	Code
Urology / Retrograde Pyelography / Gynaecology Extension - with UK Side Bar	21397-UK
Urology / Retrograde Pyelography / Gynaecology Extension - with EU Side Bar	21397-EU

## Push / Pull Bar



Description	Code
Push / Pull Bar	21390

## Oxygen Delivery Bar and Drape Screen

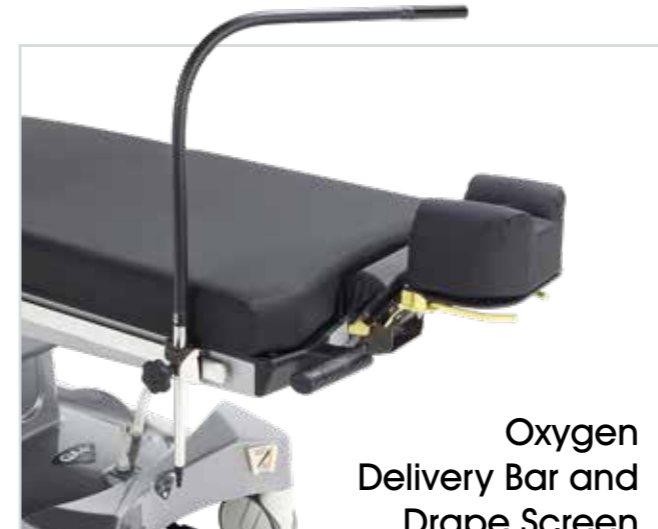

Description	Code
Oxygen Delivery Bar & Drape Screen	21365

# OPTIONAL EXTRAS

## Foot-end Extension



Description	Code
Foot-end Extension - with 30mm Deep Mattress	21395

## Arm Supports



Description	Code
Lateral / Prone Arm Support c/w Pad	10773
Carter Braine Arm Support c/w Pad	10195

## Side Rail Covers



Description	Code
Side Rail Cover - PADDED - for Single-piece Side Rail - GREY Material - PAIR	21347
Side Rail Cover - PADDED - for Single-piece Side Rail - CHILD PRINT Material - PAIR	21348



DESIGN & INNOVATION



MADE IN THE UK



GLOBAL DISTRIBUTION

Customise your surgery system with specialist accessories

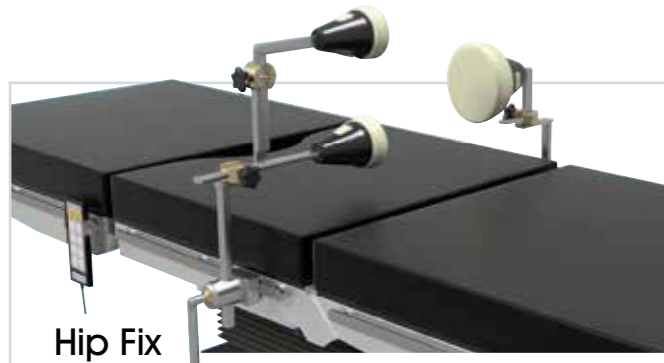

## Hip Fix

Description	Code
Hip Fix™ (2015-2000) 3-point Fixation System - includes sacrum positioner & vertically mounted iliac crest positioner. Single-use pad set & clamps (two required per system) sold separately	10470
Hip Fix™ Rotary Clamp (10-305-P) - Hook-on for UK Side Bar with Flat Pushing Plunge	10470-C1
Hip Fix™ Rotary Clamp (10-305-P) - Hook-on for EU Side Bar with Flat Pushing Plunge	10470-C2
Hip Fix™ Single-use Pad Set - includes one sacrum & two iliac crest positioner pads (Pack of 25)	10470-P1



## Lateral Brace 3-Piece

Description	Code
Lateral Brace 3-Piece c/w Rectangular x2, Circular x1 Supports	10770



## Clamps

Description	Code
Clamp - Basic Blade Handwheel - for UK and EU Side Bar	10761
Clamp - Rotary Socket - Stainless Steel - Hook-on - Universal for UK / EU / US Side Bar	10248
Clamp - Universal (Socket & Rail) - Handwheel - for UK / EU / Swiss Side Bar	10250

## Operating Table Accessories Stand

Accessories need storage when not in use – and we have the perfect solution.

Our accessories trolley is a compact, mobile storage system which helps to keep a busy theatre environment tidy and uncluttered.

- Adaptable
- Robust
- Multi-functional
- UK or EU Side Bar options



Description	Code
Operating Table Accessories Stand - Mobile - with UK Side Bar	21370
Operating Table Accessories Stand - Mobile - with EU Side Bar	21370E

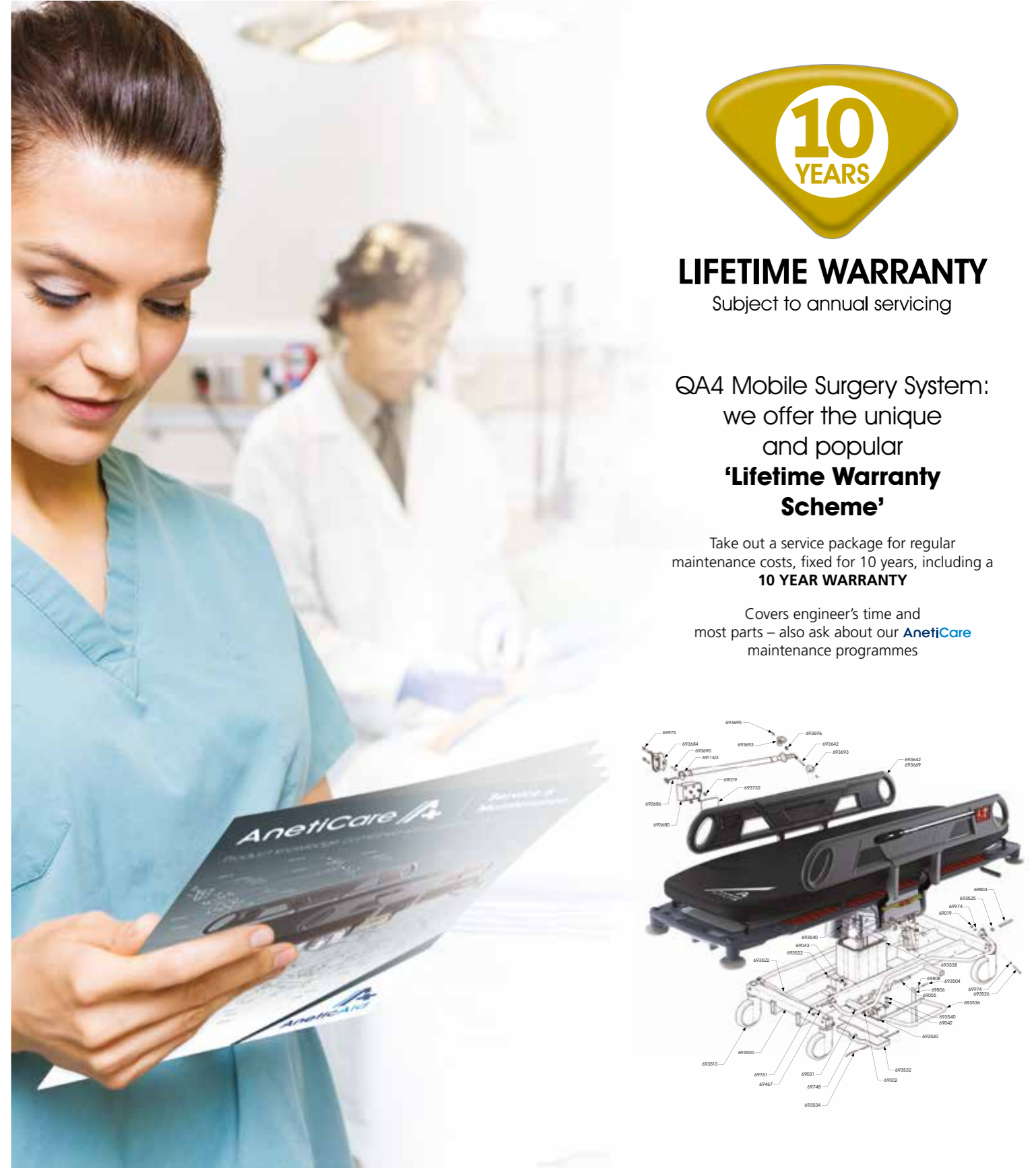

## LIFETIME WARRANTY

Subject to annual servicing

QA4 Mobile Surgery System: we offer the unique and popular **'Lifetime Warranty Scheme'**

Take out a service package for regular maintenance costs, fixed for 10 years, including a **10 YEAR WARRANTY**

Covers engineer's time and most parts – also ask about our **AnetiCare** maintenance programmes

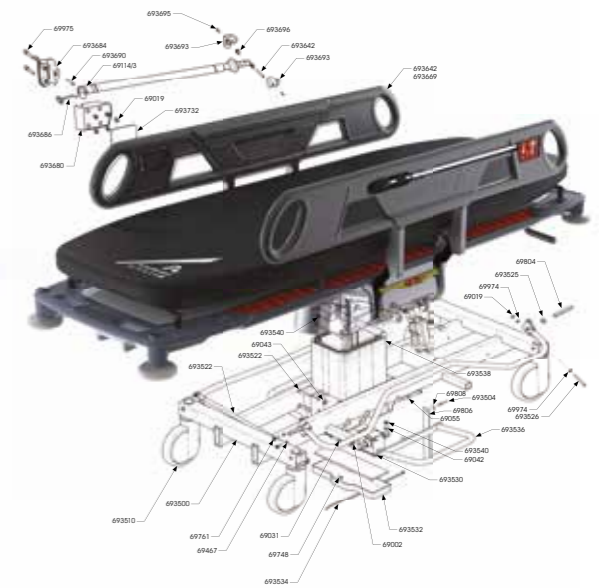

Value for money: minimum downtime, maximum peace of mind



DESIGN & INNOVATION



MADE IN THE UK



GLOBAL DISTRIBUTION

# OUR PRODUCT AREAS

SEE ALSO



**QA3 Patient Trolley System:**  
Compact, light weight and manoeuvrable – the complete solution for patient transport

**PLUS**  
our other product areas



Scan this code to start a **WhatsApp** chat with Anetic Aid



For more information on any of our products or service contracts, call:  
[sales@aneticaid.com](mailto:sales@aneticaid.com) **+44 (0)1943 878647** [aneticaid.com](http://aneticaid.com)



Innovative **Medical** Technology - **Practically Applied**



**Anetic Aid Ltd**, Sapper Jordan Rossi Business Park, Otley Road, Baildon BD17 7AX, UK