

# Public Safety

PPE Dispensing Solutions

2022 E-BROCHURE

**BOWMAN®**



**Dispensers**

Organize • Contain • Comply®



# catalog legend

Our goal is to make your life easier. You'll find just what you're looking for in a breeze with our easy to spot colorful icons throughout the catalog.

## Look for Key Feature Icons

Key feature icons let you know about special product features that can help you chose the best product to fit your needs.



## Online Tools & Product Videos



### product videos

Learn more and watch demonstration videos: [BowmanDispensers.com/Videos](http://BowmanDispensers.com/Videos)

- |   |                                       |
|---|---------------------------------------|
| <b>(ABS)</b> ABS Plastic 02               | <b>(PET)</b> PETG Plastic 01          |
| <b>(ACM)</b> Aluminum Composite Materials | <b>(PLC)</b> Polycarbonate Plastic 12 |
| <b>(AFP)</b> ABS Fauxwood Plastic 02      | <b>(STP)</b> Sintra® Plastic 07       |
| <b>(ALM)</b> Aluminum 05                  | <b>(STS)</b> Stainless Steel 03       |
| <b>(CRS)</b> Cold Rolled Steel 04         | <b>(WIR)</b> Powder-Coated Wire 06    |
| <b>(PE)</b> Polyethylene                  |                                       |

## material

- |                               |                             |
|-------------------------------|-----------------------------|
| <b>(●)</b> Bay Gray 29        | <b>(○)</b> Clear 11         |
| <b>(●)</b> Black 20           | <b>(○)</b> Frosted Clear 14 |
| <b>(●)</b> Cherry 33          | <b>(○)</b> Quartz Beige 12  |
| <b>(●)</b> Maple 23           | <b>(○)</b> White 13, 34     |
| <b>(○)</b> Stainless Steel 00 |                             |

## color

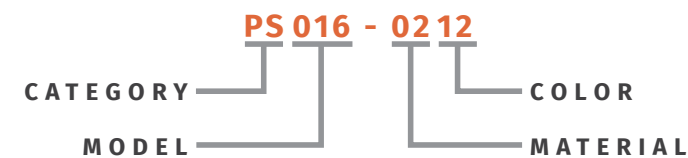

Example: **PS016-0212**

Protective Wear Organizer, Model 016, ABS, Quartz Beige

## product number

*Visit our website for extended material and color information. Colors may vary. Not all colors or materials are available for all dispensers. Use the material codes shown in this catalog as a reference for what a particular dispenser is made from. Custom options are also available.*

# find your solution



## Cover Your Cough Compliance Kits & Hand Hygiene Dispensing Systems .....4

- Hand Hygiene Solutions..... 4
- How to Choose Guide ..... 8
- Cover Your Cough Compliance Kits ..... 10
- Semi-Recessed Dispensers..... 14
- Physical & Protective Barriers .....15



## Face Mask Dispensers .....16

- Bulk.....16
- Public Safety Kit..... 18
- Universal ..... 20
- Specialty.....21
- Cross Reference.....22

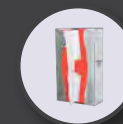

## Specialty Dispensers..... 28



## Index.....32



# public areas

## HAND HYGIENE STATIONS



**KS101-0029\*** (CRS)

**Hand Sanitizer Floor Stand**

*Floor Stand & Dispenser Back Plate*

*Accommodates most major manufacturers' automatic hand sanitizer, lotion, and foam dispensers.*

## Hand Hygiene Dispensing Systems

PPE stands offer supplies in the right place at the right time. Keep them near entryways, public areas, or break rooms so safety is always top of mind.



**BD004-0012** (CRS)

**Large Capacity Bottle Dispenser Kit**

*Accommodates most major manufacturers' large capacity hand sanitizer, lotion, and foam bottles.*



**BD990-0020** (CRS)

**Cover Your Cough Compliance Kit**

*Accommodates most major manufacturers' automatic hand sanitizer, lotion, and foam dispensers.*



**KS022-0012** (CRS)

**Dual-Sided Floor Stand**

*Accommodates most major manufacturers' automatic hand sanitizer, lotion, and foam dispensers.*

*Other station options:*

KS022-0020 ●

BD119-0000 Public Safety Kit ○



Hand sanitizers not included. All consumable items are for demonstration purposes only and are not available for purchase through BOWMAN®



# cover your cough

COMPLIANCE KITS

## Guard against the unknown with Respiratory Hygiene Solutions from BOWMAN:

- Convenient access to PPE
- Standardized dispensing location
- Supports best practice adherence
- Enhances patient, staff, and visitor safety
- Drives refill compliance
- Contains costs by preventing Hospital Associated Infections (HAI's) and outbreak investigations



TAKE PRECAUTIONS TO  
**prevent**  
THE SPREAD  
OF INFECTION



Download Free multilingual  
Cover Your Cough Signs at  
[BowmanDispensers.com](http://BowmanDispensers.com)

## Comply with the 4-step CDC Guidelines:

- 1 Visual Alerts**  
Post visual alerts at the entrances of healthcare facilities, including emergency departments, physician offices, clinics, etc.
- 2 Cleaning Hands**  
Use of antiseptic hand wash if a sink for hand washing is not available.
- 3 Wearing Face Masks**  
Wear a mask if coughing.  
Masks available for visitor use.
- 4 Using Tissues**  
Cover the nose and mouth with a tissue when coughing or sneezing and properly dispose of tissues after use.



Based on the CDC's Respiratory Hygiene/Cough Etiquette in Healthcare Settings Guidelines: <http://www.cdc.gov/flu/professionals/infectioncontrol/resphygiene.htm>  
All consumable items are for demonstration purposes only and are not available for purchase through BOWMAN®



**CYC compliance  
kits video:**  
[BowmanDispensers.com/  
Product-Videos](http://BowmanDispensers.com/Product-Videos)



# Cover Your Cough Compliance Kits Guide

1

**Determine Layout**  
BASED ON HAND SANITIZER



2

**Choose Security Level**  
LOCKING LID OR NO LID

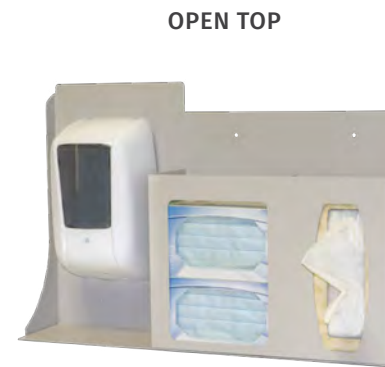
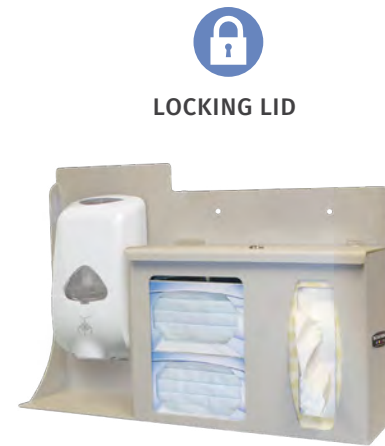

3

**Select Color & Material**  
PLASTIC OR STEEL



**CHERRY ABS FAUXWOOD PLASTIC**



**MAPLE ABS FAUXWOOD PLASTIC**



# HOW TO CHOOSE YOUR CUSTOM STATION

4

**Pick Sign Direction**  
VERTICAL OR HORIZONTAL

VERTICAL



HORIZONTAL



5

**Identify Location for Dispensing**  
COUNTER/WALL OR FREESTANDING

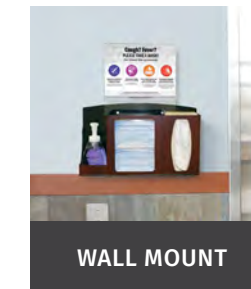

6

**Review Options**  
SEE PAGES 10-13 FOR EXAMPLES



# protect

YOUR PATIENTS, YOURSELF  
& YOUR FAMILY

Have PPE in sight when and where you need it. Place a Cover Your Cough Compliance Kit on a countertop in your front office, or mount it on a wall near the elevator. Perfect for any public area.

## Countertop & Wall Mount

AUTOMATIC PUMP OR FOAM SANITIZER

**BD216-0012** (ABS) (Lock)

Quartz Beige  
Station: ABS Plastic  
Sign: PETG Plastic

Other options:  
BD206-0012 (CRS) (Lock)  
BD214-0012 (ABS)



Hand sanitizers not included

## Countertop & Wall Mount

TISSUE & FACE MASKS

**BD322-0012** (ABS) (Lock)

Quartz Beige  
Station: ABS Plastic  
Sign: PETG Plastic



## Countertop & Wall Mount

BOTTLED SANITIZER OR WIPES

**BD211-0012** (ABS)

Quartz Beige  
Station: ABS Plastic  
Sign: PETG Plastic

Other options:  
BD201-0012 (CRS)  
BD211-0023 (AFP)  
BD211-0033 (AFP)



## Countertop & Wall Mount

LOCKING BOTTLE AREA

**BD262-0012** (ABS) (Lock)

Quartz Beige  
Station: ABS Plastic  
Sign: PETG Plastic  
Lid: PETG Plastic



Restaurants  
WAITING ROOMS & LOBBIES  
PUBLIC TRANSIT Airports  
All Ports of Entry  
CLASSROOMS Arenas CHURCHES  
Distribution Centers  
Libraries





# take a stand

AGAINST THE SPREAD OF INFECTION

Freestanding Cover Your Cough Compliance Kits offer infection control supplies to be in the right place at the right time. Keep them near entryways and in public waiting areas so infection control is always top of mind.



**CYC compliance kits video:**  
BowmanDispensers.com/  
Product-Videos

## Freestanding BOTTLED SANITIZER OR WIPES



**BD111-0012** (ABS)

Quartz Beige

Station: ABS Plastic

Stand: Steel

Sign: PETG Plastic

Other station options:

BD101-0012 (CRS)

BD111-0023 (AFP)

BD111-0033 (AFP)

BD162-0012 (ABS)

Hand sanitizers not included

## Freestanding AUTOMATIC PUMP OR FOAM SANITIZER



**BD116-0012** (ABS)

Automatic Pump

Quartz Beige

Station: ABS Plastic

Stand: Steel

Sign: PETG Plastic

Other station options:

BD106-0012 (CRS)

BD114-0012 (ABS)

BD116-0023 (AFP)

BD116-0033 (AFP)



**BD117-0020** (ABS)

Automatic Pump

Black

Station: ABS Plastic

Stand: Steel

Sign: PETG Plastic

Other station options:

BD117-0012 (ABS)

BD990-0020 (ABS)

All consumable items are for demonstration purposes only and are not available for purchase through BOWMAN®

# protection for any setting

Semi-Recessed solutions are a smart choice for high traffic areas, such as hallways or near elevators. Our in-wall solutions avoid wall protrusion rule concerns while keeping necessities organized and at hand.

**RE304-0012** CRS  
**Hand Sanitizer Station**  
 12.35"W x 18.85"H x 4.22"D

- Universal Wall well for housing hand sanitizer dispensers
- Embossed drip tray designed to contain over dispensing
- Accommodates most front loading hand sanitizer manufacturers dispensers (required dispensing clearance) less than: 11.30"W x 17.94"H x 5.00"D



**SN304-0713** STP  
**Sign - Hand Sanitizer Station**  
 6.30"W x 6.00"H x 3.71"D

- Optional 3D sign
- "V" shape projects 45° from wall allowing for easy visualization from front and sides.

## Semi-Recessed Hygiene Dispensers



**RE401-0012** CRS  
**Face Mask & Glove Box Dispenser**  
 12.34"W  
 24.48"H  
 4.77"D



**RE302-0012** CRS  
**Face Mask & Tissue Dispenser**  
 12.34"W  
 18.83"H  
 4.77"D

## Physical & Protective Barriers new

Retain versatility and safety in any environment by separating wet from dry and clean from dirty while keeping the workspace, staff, and equipment protected.



### Physical Barrier



**PB004-0811** - Short  
 4.5"W x 16"H x 15.75"D

**PB005-0811** - w/Sign Holder  
 4.50"W x 19.25"H x 23.63"D

**PB006-0811** - Small  
 6"W x 20"H x 20"D

### Physical Barrier with Suction Cups



**PB001-0811** - Short  
 4.25"W x 16"H x 15.75"D

**PB002-0811** - Small  
 4.25"W x 18"H x 19"D

**PB003-0811** - Medium  
 4.25"W x 18"H x 23.50"D

### Physical Barrier with Cutaway

**PB007-0811** - Short  
 4.50"W x 16"H x 15.75"D

**PB008-0811** - Small  
 4.50"W x 18"H x 19"D

**PB009-0811** - Medium  
 4.50"W x 18"H x 23.63"D

**PB010-0811** - Large  
 4.50"W x 18.10"H x 29.60"D

**PB011-0811** - X-Large  
 4.50"W x 18.10"H x 35.60"D



### Portable Protective Barrier with Pass Through Opening



**PB012-1211** - X Large  
 36"W x 31"H x 11.5"D

**PB017-1211** - Large  
 23.5"W x 31"H x 11.5"D

### Tabletop Protective Barrier

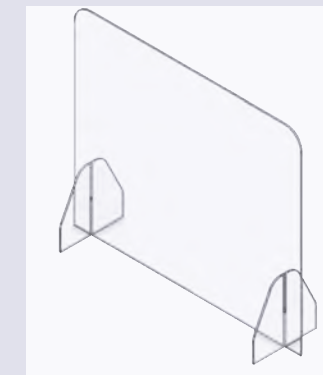

**PB016-1211**  
 28"W x 23.75"H x 7.75"D

### Tabletop Protective Barrier with Hinge

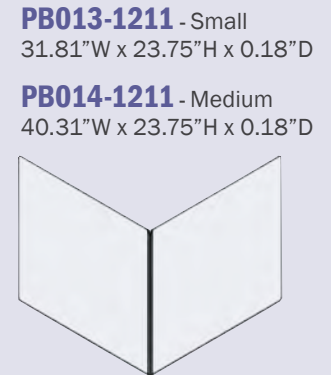

**PB013-1211** - Small  
 31.81"W x 23.75"H x 0.18"D

**PB014-1211** - Medium  
 40.31"W x 23.75"H x 0.18"D

**PB015-1211** - Large  
 50.31"W x 23.75"H x 0.18"D



# dispensing smiles

ACROSS EVERY INDUSTRY



learn more about face mask dispensers:  
BowmanDispensers.com/  
Product-Videos

Determine which BOWMAN Face Mask Dispenser fits your style and brand of face masks:

cross reference: pages 22-27



## Signature Series Bulks

Holds face masks in bulk quantities available with maple or cherry fauxwood lids.



**FM019-0223** (AFP) (ABS)  
Bulk - Countertop



**FM019-0233** (AFP) (ABS)  
Bulk - Countertop

## Standard Shield & Cone Bulks

Holds face masks in bulk quantities.



**FM402-0111** (PET)   
4" Face Shields



**FP-017** (PET)  
Compact



**BK004-0111** (PET)  
Large Capacity

All consumable items are for demonstration purposes only and are not available for purchase through BOWMAN®

## Standard Earloop Bulks

Holds face masks in bulk quantities.



**FD-005** (PET) (ABS)   
One Box Capacity



**FM401-0111** (PET)   
4" Earloops







MAKE SAFETY  
**priority**

**BD119-0000** (PET) (ALM) (CRS)

Public Safety Kit

Kit includes:

- FM403-0111 Face Mask Dispenser
- MP-070 Sign Holder
- KS022-0012 Dual-Sided Floor Stand <sup>1</sup>

Also available:  
KS022-0020 ●

**Large Capacity Bulk** <sup>USP 800</sup>  
Holds 5 boxes of face masks in bulk, and dispenses from the bottom with locking lid.



**FM403-0212** (ABS)  
Quartz Beige

Also Available:  
FM403-0111 (PET)  
FM403-0213 (ABS)  
FM403-0220 (ABS)

**Signature Series**



**FM403-0223** (AFP)  
Maple

**FM403-0233** (AFP)  
Cherry

**Signature Series**



**FM404-0223** (AFP)  
Maple

**FM404-0233** (AFP)  
Cherry

**Small Capacity Bulk** <sup>USP 800</sup>

Holds 3 boxes of face masks in bulk, and dispenses from the bottom with locking lid.



**FM404-0111** (PET)  
Clear

**FM404-0213** (ABS)  
White

**FM404-0212** (ABS)  
Quartz Beige

**FM404-0220** (ABS)  
Black

<sup>1</sup>KS022-0012 Dual-Sided Floor Stand accommodates all FM403 and FM404 Face Mask Dispensers



# THANK YOU FOR masking



learn more about  
quality dispensers:  
[BowmanDispensers.com/  
Product-Videos](http://BowmanDispensers.com/Product-Videos)

## Universal

- Switch your supplier and keep your dispenser
- Holds a variety of boxed face masks
- Accommodates most brands

**FM100-0212** (ABS)  
Earloops



**FM200-0212** (ABS)  
Face Shields



**FM300-0212** (ABS)  
Cones



PATENT: [www.BowmanDispensers.com/patents](http://www.BowmanDispensers.com/patents)

## Combo

Multiple styles of face masks in one location.

**FM001-0212** (ABS)  
Surgical  
Also available  
with sign holders  
FM004-0212



**FM002-0212** (ABS)  
Combo



## Exact Fit

Exact fit for most  
standard size boxes.



**FB-037** (CRS)  
Earloops









**FM063-0300** (STS)  
Ties  
Also available  
FB-091 (CRS)



**FM090-0300** (STS)  
Face Shields  
Also available  
FB-090 (CRS)







Face Mask Dispensers Cross Reference Guide		Dispenser Dims W (L) x H x D		3M	Cardinal Health	Condor	Gerson	Halyard Health	McKesson
		IN	CM						
Box		8.25 4.63 5.75	21.0 11.8 14.6						
	<b>FM100-0212</b> (ABS)								
top seller		8.66 4.98 4.38	22.0 12.6 11.1						
	<b>FD-005</b> (PET) (ABS)								
top seller		8.25 5.63 4.00	21.0 14.3 10.2						
	<b>FM401-0111</b> (PET) (4")								
EARLOOP		9.45 6.75 4.75	24.0 17.1 12.1	1800, 1816, 1820, 1826, 1832, 1838	AT71021, AT7511, AT7511-WE, AT771141, AT771211, AT771212			28802, 28806, 28808, 37525, 39117, 41805, 48100, 48105, 48201, 48215, 48296, 49214, 49310, 49701, 59927, 59928, 59929, 59931, 62113, 62367, 62369	91-1000, 91-1200, 91-1400, 91-2002
	<b>FM019-0223</b> (AFP) (ABS)								
Bulk		9.45 6.75 4.75	24.0 17.1 12.1						
	<b>FM019-0233</b> (AFP) (ABS)								
	<ul style="list-style-type: none"> <li>FM404-0111 ○</li> <li>FM404-0212 ●</li> <li>FM404-0213 ○</li> <li>FM404-0220 ●</li> <li>FM404-0223 ●</li> <li>FM404-0233 ●</li> </ul>		8.38 10.00 4.43 4.43	21.3 25.4 11.3					
top seller	<ul style="list-style-type: none"> <li>FM403-0111 ○</li> <li>FM403-0212 ●</li> <li>FM403-0213 ○</li> <li>FM403-0220 ●</li> <li>FM403-0223 ●</li> <li>FM403-0233 ●</li> </ul>		8.38 16.39 4.43	21.3 41.6 11.3					

Information in this cross reference is subject to change.

MediChoice PrimaGuard/PriMed	Medline	Moldex	NovaPlus	Precept	Premier Pro	Sperian
	NON27110, NON27120, NON27120-2, NON27122, NON27355, NON27361A, NON27365, NON27373A, NON27374, NON27375, NON27376, NON27377, NON27378, NON27378A, NON27379A, NON27382, NON27382FR, NON27385, NON27386, NON27400, NON27402, NON27408, NON27408EL, NON27410, NON27410EL, NON27412, NON27412EL, NON27600, NON27600AG, NON27710, NON27710EL, NON27712, NON27712EL, NON27810, NON27810EL, NON27812EL		V47572, V47578	15100, 15101, 15130, 15150, 15155, 15160, 15200, 15211, 15212, 15216, 15220, 15230, 15240, 15260, 15300, 15320, 15420, 15500, 65-3320, 65-3322	2460, 2463, 2464, 2465, 2466, 2470, 2472	











Face Mask Dispensers Cross Reference Guide		Dispenser Dims W (L) x H x D		3M	Cardinal Health	Condor	Gerson	Halyard Health	McKesson
		IN	CM						
SHIELD	Box		9.75 8.63 4.75	24.8 21.9 12.1	1818, 1870, 1870-N95, 9210/37021		22EL77	28804, 28809, 28821, 39123, 41803, 47095, 47137, 47147, 47148, 47149, 47298, 47500, 48228, 48237, 48247, 48248, 48257, 48298, 59930, 59937, 62114, 62116, 69801	91-1600, 91-2600
		FM200-0212 (ABS)							
SHIELD	Bulk		12.00 9.00 4.08	30.5 22.9 10.4					
		FM402-0111 (PET) <sup>4"</sup>							
CONE	Box		6.75 7.13 5.75	17.1 18.1 14.6	1860, 8000, 8210, 8240, 8246, 8247, 8511, 8576, 8577, 1800+NL, 1800NL, 1860S	N95A-S	22EL78, 22EL79, 22EL80, 22EL81, 4KMX9	47200, 47407, 47707, 47817, 62127, 62354, 63037, 63149, 63152	
		FM300-0212 (ABS)							
CONE	Bulk		6.70 9.00 6.01	17.0 22.9 15.3			081730, 081735, 081740, 081745, 081750, 081760, 081940, 061501-CS		
		FP-017 (PET)							
CONE	Bulk		9.00 12.50 5.96	22.9 31.8 15.1					
		BK004-0111 (PET)							

MediChoice PrimaGuard/PriMed	Medline	Moldex	NovaPlus	Precept	Premier Pro	Sperian
PG41573, PG41592, PG42560, PG42562, PG43573, PG45073, PG46003, PG46403	NON27405, NON27411, NON27411AG		V47570	15310, 15330, 15710, 65-3344	2451, 2461, 2462, 2467, 2480, 2481, 2492	7230N95
PG4303	N7120, NON24506A, NON24570A, NON27381	1510, 1511, 1512, 1513, 1517, 1712, 2112, 2250, 2350, 2850, 4200, 4201, 4600, 4601, 4800, 1200N95, 1201N95, 1207N95, 2200N95, 2200N95HV, 2201N95, 2207N95, 2210GN95, 2211GN95, 2212GN95, 2217GN95, 2300N95, 2301N95, 2307N95, 2600N95, 2601N95, 2607N95, 2700N95, 2701N95, 2707N95, 2730N100, 2731N100, 2740R95, 2741R95, 2800N95, 2801N95, 2840R95, 2841R95, 2940R95, 2941R95, 4300P95, 4700N100, D2740R95, M2600N95, M2601N95, M2700N95, M2701N95, M2707N95, M2740R95, M2741R95, M2800N95, M2801N95, M2840R95	65-3333, 65-3395, 65-3395S	2490	14110388	

Information in this cross reference is subject to change.



Face Mask Dispensers Cross Reference Guide		Dispenser Dims W (L) x H x D		3M	Cardinal Health	Condor	Gerson	Halyard Health	McKesson
		IN	CM						
EARLOOP	 <b>FB-037</b> (CRS)	7.56 4.25 4.13	19.2 10.8 10.5		AT7511, AT71021, AT771141, AT771211, AT771212			25867, 25868, 25869, 28797, 28810, 32856, 41802, 47080, 47085, 47090, 47107, 47108, 47117, 47119, 47127, 47295, 47297, 49700, 59936, 59938, 59939, 59940, 62115, 62356, 62357, 62362, 62363, 62364	91-2002
EARLOOP	 <b>FB-064</b> (CRS)	7.56 4.25 4.13	19.2 10.8 10.5		AT71021, AT7511, AT771141, AT771211, AT771212			25867, 25868, 25869, 28797, 28810, 32856, 41802, 47080, 47085, 47090, 47107, 47108, 47117, 47119, 47127, 47295, 47297, 49700, 59936, 59938, 59939, 59940, 62115, 62356, 62357, 62362, 62363, 62364	91-2002
SHIELD	 <b>FB-090</b> (CRS)	9.06 7.53 4.06	23.0 19.1 10.3	1818	AT54635, AT71039, AT744335, AT74631, AT74635, AT7509			28804, 28809, 28821, 41803, 47137, 47147, 47148, 47149, 47298, 47500, 48228, 48237, 48247, 48248, 48257, 48298, 59930, 59937, 62114, 62116, 69801	91-1600, 91-2600
TIE	 <b>FB-091</b> (CRS)	7.90 7.70 5.00	20.1 19.6 12.7	1832	AT51035, AT51334, AT71035, AT72835, AT73335, AT73835, AT744235, AT74535, AT7505-P, AT752005, AT752007, AT75835, AT771145, N95A-ML			28820, 37505, 37510, 39125, 47625, 47650, 48207, 48208, 48210, 48220, 48225, 48227, 48297, 48390, 49210, 49212, 49215, 49216, 49230, 49235, 59926, 62368	
SHIELD	 <b>FM006-0111</b> (PET)	11.83 7.50 4.20	30.0 19.0 10.7		AT74635-I, AT771145A			39118, 39124	
EARLOOP	 <b>FP-021</b> (PET)	7.95 4.23 5.20	20.2 10.7 13.2		N95A-ML				91-1200
EARLOOP	 <b>FP-038</b> (PET)	7.70 4.32 4.27	19.6 11.0 10.8		AT71021, AT7511, AT771141, AT771211, AT771212			25867, 25868, 25869, 28797, 28802 28806, 28808, 28810, 32856, 37525, 41802, 41805, 47080, 47085, 47090, 47107, 47108, 47117, 47119, 47127, 47295, 47297, 48100, 48105, 48201, 48215, 48296, 49214, 49310, 49700, 49701, 59927, 59928, 59929, 59931, 59936, 59938, 59939, 59940, 62113, 62115, 62356, 62357, 62362, 62363, 62364, 62367, 62369	91-2002
SHIELD	 <b>FP-120</b> (PET)	9.20 7.50 4.20	23.4 19.1 10.7		AT54635, AT71021, AT71039, AT744335, AT74631, AT74635, AT7511, AT771141, AT771211, AT771212			28804, 28809, 28821, 41803, 47137, 47147, 47148, 47149, 47298, 47500, 48228, 48237, 48247, 48248, 48257, 48298, 59930, 59937, 62114, 62116, 69801	91-1600, 91-2600

MediChoice PrimaGuard/PriMed	Medline	Moldex	NovaPlus	Precept	Premier Pro	Sperian
PG41092, PG41200, PG41241, PG42331	NON27120-2, NON27122, NON27355, NON27375, NON27378		V47566, V47567, V47568, V47569, V47573		2450	
PG41092, PG41200, PG41241, PG42331	NON27120-2				2450	
PG41573, PG41592, PG45073	NON27361A, NON27410EL, NON27710EL, NON27810EL, NON27361A, NON27371A, NON27376, NON27377, NON27385, NON27386, NON27400, NON27408, NON27408EL, NON27710EL			15310, 15330, 15710, 65-3344		
PG43573	NON27412, NON27371A, NON27712				2462	
PG41241, PG42332				15100, 15101, 15130, 15150, 15155, 15160, 15200, 15211, 15212, 15216, 15220, 15230, 15240, 15260, 15300, 15320, 15420, 15500, 65-3320, 65-3322	2450	
PG41092, PG41200, PG41201, PG41241, PG42331	NON27110, NON27120-2, NON27365, NON27374, NON27410, NON27410EL, NON27600, NON27600AG, NON27710, NON27710EL, NON27810, NON27810EL				2410, 2420, 2430, 2452, 2453, 2454	
PG41573, PG41592, PG45073	NON24505			15310, 15330, 15710, 65-3344		14110452

# specialty

## DISPENSERS



**WB-711** (ALM)  
Disposable Wipe Dispenser



**FM013-0212** (ABS)  
Face Mask - Triple  
Also available as a quintuple *FM014-0212*

All consumable items are for demonstration purposes only and are not available for purchase through BOWMAN®



### Wax Paper, Eyewear, Hairnet, and Towel Dispensers



**FS001-0300** (STS)  
Wax Paper Dispenser  
Also available - *FS001-0111* (PET)



**CP-072** (ABS) (PET)  
Eyewear Cabinet  
Holds 6 pairs of eyewear



**HP-010** (PET) **top seller**  
Hairnet Dispenser



**TB-003** (CRS)  
Towel Dispenser

### Sign Holders



**MP-075** (PET)  
Horizontal Sign Holder



**MP-070** (PET)  
Vertical Sign Holder

### CPR, Face Mask, Bulk, and Epi Pen Dispensers

**NC010-0111** (PET)  
CPR Holder  
Holds most manufacturers' CPR clam kits.



**BK103-0111** (PET) **USP <800-**  
Bulk Dispenser - Triple - Mini



**FM001-0212** (ABS)  
Surgical Face Mask  
Also available with sign holders *FM004-0212*



**ED-760** (STP) (PET)  
Epinephrine Injector Dispenser  
Holds 10 Epinephrine Injectors  
Also available - *ED-750* (holds 5) (ABS) (PET)







# facilities maintenance

STORAGE & SUPPLY CLOSETS

Infection prevention starts with a clean environment. Organize your facilities maintenance PPE with BOWMAN Bulk and Glove Box Dispensers.

## Glove Box Dispensers



**GL100-0212** (ABS) **Single**  
Also available:  
Triple - GL300-0212



**GL300-1214** (PLC) **Triple**  
Also available:  
Single - GL100-1214

## Bulk & Eyewear Dispensers



**FP-017** (PET) (USP <800>) **Compact**



**BP-021** (PET) (USP <800>) **Short - Single**



**BP-023** (PET) (USP <800>) **Short - Triple**



**GC-009** (STP) **Glove**

## Bag Dispensers



**BG001-0220** (ABS) (new) **Single**  
Also available:  
BG001-0111 (PET)  
BG001-0212 (ABS)  
BG001-0512 (ALM)

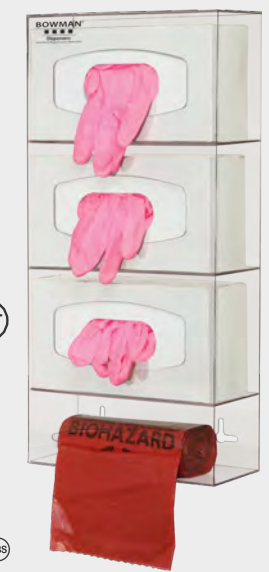

**PS004-0111** (PET) **Single**  
Holds one roll of bags up to 9.50" long and 3.40" diameter  
Also available:  
PS004-0212 (ABS)



Part Number	Product Name	Page	Unit	W (L)	H	D	Product Weight	
<b>BD004-0012</b>	Large Capacity Bottle Holder - Includes: Quartz Beige Aluminum Bottle Holder, Quartz Beige Powder-Coated Steel Floor Stand	5	IN	17.00	41.51	17.00	LB	15.2
			CM	43.2	105.4	43.2	KG	6.9
<b>BD101-0012</b>	Cover Your Cough Compliance Kit (Bottle) with Vertical Sign Holder - Includes: Quartz Beige Powder-Coated Steel Station, Quartz Beige Powder-Coated Steel Floor Stand, Clear PETG Plastic Sign Holder	Referenced 12	IN	18.00	59.10	18.00	LB	20.7
			CM	45.7	150.1	45.7	KG	9.4
<b>BD106-0012</b>	Cover Your Cough Compliance Kit (Back Plate) - Locking with Horizontal Sign Holder Includes: Quartz Beige Powder-Coated Steel Station, Quartz Beige Powder-Coated Steel Floor Stand, Clear PETG Plastic Sign Holder	Referenced 13	IN	22.25	57.98	18.00	LB	22.0
			CM	56.5	147.3	45.7	KG	10.0
<b>BD111-0012</b>	Cover Your Cough Compliance Kit (Bottle) with Vertical Sign Holder - Includes: Quartz Beige ABS Plastic Station, Quartz Beige Powder-Coated Steel Floor Stand, Clear PETG Plastic Sign Holder	12	IN	18.00	58.36	18.00	LB	19.2
			CM	45.7	148.2	45.7	KG	8.7
<b>BD111-0023</b>	Cover Your Cough Compliance Kit (Bottle) with Vertical Sign Holder - Includes: Fauxwood Maple ABS Plastic Station, White Powder-Coated Steel Floor Stand, Clear PETG Plastic Sign Holder	Referenced 12	IN	18.00	58.36	18.00	LB	19.3
			CM	45.7	148.2	45.7	KG	8.8
<b>BD111-0033</b>	Cover Your Cough Compliance Kit (Bottle) with Vertical Sign Holder - Includes: Fauxwood Cherry ABS Plastic Station, Black Powder-Coated Steel Floor Stand, Clear PETG Plastic Sign Holder	Referenced 12	IN	18.00	58.36	18.00	LB	18.8
			CM	45.7	148.2	45.7	KG	8.5
<b>BD114-0012</b>	Cover Your Cough Compliance Kit (Back Plate) with Horizontal Sign Holder - Includes: Quartz Beige ABS Plastic Station, Quartz Beige Powder-Coated Steel Floor Stand, Clear PETG Plastic Sign Holder	Referenced 13	IN	22.25	58.06	18.00	LB	18.6
			CM	56.5	147.5	45.7	KG	8.4
<b>BD116-0012</b>	Cover Your Cough Compliance Kit (Back Plate) - Locking with Vertical Sign Holder - Includes: Quartz Beige ABS Plastic Station, Quartz Beige Powder-Coated Steel Floor Stand, Clear PETG Plastic Sign Holder	13	IN	22.25	58.29	18.00	LB	20.8
			CM	56.5	148.1	45.7	KG	9.4
<b>BD116-0023</b>	Cover Your Cough Compliance Kit (Back Plate) - Locking with Vertical Sign Holder - Includes: Fauxwood Maple ABS Plastic Station, White Powder-Coated Steel Floor Stand, Clear PETG Plastic Sign Holder	Referenced 13	IN	22.25	58.29	18.00	LB	20.8
			CM	56.5	148.1	45.7	KG	9.4
<b>BD116-0033</b>	Cover Your Cough Compliance Kit (Back Plate) - Locking with Vertical Sign Holder - Includes: Fauxwood Cherry ABS Plastic Station, Black Powder-Coated Steel Floor Stand, Clear PETG Plastic Sign Holder	Referenced 13	IN	22.25	58.29	18.00	LB	20.8
			CM	56.5	148.1	45.7	KG	9.4
<b>BD117-0012</b>	Cover Your Cough Compliance Kit (Back Plate) - Locking with Horizontal Sign Holder - Includes: Quartz Beige ABS Plastic Station, Clear PETG Plastic Sign Holder	Referenced: 13	IN	22.2	58.2	17.0	LB	18.5
			CM	56.5	148.1	43.2	KG	8.4
<b>BD117-0020</b>	Cover Your Cough Compliance Kit (Back Plate) - Locking with Horizontal Sign Holder - Includes: Black ABS Plastic Station, Clear PETG Plastic Sign Holder	13	IN	22.2	58.2	17.0	LB	18.5
			CM	56.5	148.1	43.2	KG	8.4
<b>BD119-0000</b>	Public Safety Kit - Includes: FM403-0111 Face Mask Dispenser, MP-070 Sign Holder, KS022-0012 Dual-Sided Floor Stand	18	IN	17.00	64.58	17.00	LB	19.4
			CM	43.2	164.4	43.2	KG	8.8
<b>BD162-0012</b>	Cover Your Cough Compliance Kit (Bottle) - Locking with Vertical Sign Holder - Includes: Quartz Beige ABS Plastic Station, Quartz Beige Powder-Coated Steel Floor Stand, Clear PETG Plastic Sign Holder	Referenced 12	IN	18.50	57.44	18.00	LB	20.3
			CM	47.0	145.9	45.7	KG	9.2
<b>BD206-0012</b>	Cover Your Cough Compliance Kit (Back Plate) - Locking with Horizontal Sign Holder - Includes: Quartz Beige Powder-Coated Steel Station, Clear PETG Plastic Sign Holder	Referenced 10	IN	22.25	21.92	5.00	LB	5.4
			CM	56.5	55.7	12.7	KG	2.4
<b>BD211-0012</b>	Cover Your Cough Compliance Kit (Bottle) with Vertical Sign Holder - Includes: Quartz Beige ABS Plastic Station, Clear PETG Plastic Sign Holder	11	IN	17.90	22.30	4.45	LB	3.2
			CM	45.5	56.6	11.3	KG	1.5
<b>BD211-0023</b>	Cover Your Cough Compliance Kit (Bottle) with Vertical Sign Holder - Includes: Fauxwood Maple ABS Plastic Station, Clear PETG Plastic Sign Holder	Referenced 11	IN	17.90	22.30	4.45	LB	3.3
			CM	45.5	56.6	11.3	KG	1.5
<b>BD211-0033</b>	Cover Your Cough Compliance Kit (Bottle) with Vertical Sign Holder - Includes: Fauxwood Cherry ABS Plastic Station, Clear PETG Plastic Sign Holder	Referenced 11	IN	17.90	22.30	4.45	LB	3.3
			CM	45.5	56.6	11.3	KG	1.5
<b>BD214-0012</b>	Cover Your Cough Compliance Kit (Back Plate) with Horizontal Sign Holder - Includes: Quartz Beige ABS Plastic Station, Clear PETG Plastic Sign Holder	Referenced 10	IN	22.25	22.40	5.00	LB	5.0
			CM	56.5	56.9	12.7	KG	2.3
<b>BD216-0012</b>	Cover Your Cough Compliance Kit (Back Plate) - Locking with Horizontal Sign Holder - Includes: Quartz Beige ABS Plastic Station, Clear PETG Plastic Sign Holder	10	IN	22.25	22.40	5.00	LB	5.0
			CM	56.5	56.9	12.7	KG	2.3

Part Number	Product Name	Page	Unit	W (L)	H	D	Product Weight	
<b>BD262-0012</b>	Cover Your Cough Compliance Kit (Bottle) - Locking with Vertical Sign Holder - Includes: Quartz Beige ABS Plastic Station with Clear PETG Plastic Lid, Clear PETG Plastic Sign Holder	11	IN	17.52	21.36	5.62	LB	4.3
			CM	44.5	54.2	14.3	KG	2.0
<b>BD322-0012</b>	Cover Your Cough Compliance Kit - Locking with Vertical Sign Holder - Includes: Quartz Beige ABS Plastic Station, Clear PETG Plastic Sign Holder	10	IN	13.80	24.08	5.47	LB	3.1
			CM	35.1	61.2	13.9	KG	1.4
<b>BD990-0020</b>	Cover Your Cough Compliance Kit (Bottle) - Locking with Vertical Sign Holder - Includes: Quartz Beige ABS Plastic Station, Quartz Beige Powder-Coated Steel Floor Stand, Clear PETG Plastic Sign Holder	5	IN	22.25	57.98	22.50	LB	22.50
			CM	56.51	147.27	57.15	KG	10.2
<b>BK004-0111</b>	Bulk Dispenser - Large, Top Dispensing - Clear PETG Plastic	16, 24, 28, 31	IN	9.00	12.69	5.96	LB	1.9
			CM	22.9	32.2	15.1	KG	0.9
<b>BK103-0111</b>	Bulk Dispenser - Mini Triple Bin, Top Dispensing - Clear PETG Plastic	29	IN	18.40	8.00	5.22	LB	2.5
			CM	46.7	20.3	13.3	KG	1.1
<b>BG001-0111</b>	Bag Dispenser - Single - Clear PETG Plastic	Referenced: 31	IN	10.10	3.6	3.95	LB	0.7
			CM	25.7	9.1	10.0	KG	0.3
<b>BG001-0212</b>	Bag Dispenser - Single - Quartz Beige ABS Plastic	Referenced: 31	IN	10.10	3.60	3.96	LB	6.6
			CM	25.7	9.1	10.0	KG	0.2
<b>BG001-0220</b>	Bag Dispenser - Single - Black ABS Plastic	31	IN	10.10	3.60	3.96	LB	6.6
			CM	25.7	9.1	10.0	KG	0.2
<b>BG001-0512</b>	Bag Dispenser - Single - Quartz Beige Powder-Coated Aluminum	Referenced: 31	IN	10.05	3.50	3.90	LB	0.9
			CM	25.5	8.9	9.9	KG	0.4
<b>BP-021</b>	Bulk Dispenser - Short Single Bin - Clear PETG Plastic	31	IN	12.50	11.50	5.86	LB	2.2
			CM	31.8	29.2	14.8	KG	1.0
<b>BP-023</b>	Bulk Dispenser - Short Triple Bin - Clear PETG Plastic	31	IN	17.80	11.50	5.87	LB	3.5
			CM	45.2	29.2	14.9	KG	1.6
<b>CP-072</b>	Eyewear Dispenser - Hinged Lid - Clear PETG Plastic	29	IN	9.25	3.45	6.91	LB	1.1
			CM	23.5	8.8	17.6	KG	0.5
<b>ED-750</b>	Epinephrine Injector Dispenser - 5 - Quartz Beige ABS Plastic and Clear PETG Plastic	Referenced: 29	IN	9.00	11.19	2.51	LB	1.9
			CM	22.9	28.4	6.4	KG	0.8
<b>ED-760</b>	Epinephrine Injector Dispenser - 10 - Yellow Sintra Plastic and Clear PETG Plastic	29	IN	9.49	11.19	4.65	LB	2.4
			CM	24.1	28.4	11.8	KG	1.1
<b>FB-037</b>	Face Mask Dispenser - Earloop Style - White Powder-Coated Steel	21, 26	IN	7.56	4.25	4.13	LB	0.7
			CM	19.2	10.8	10.5	KG	0.3
<b>FB-064</b>	Face Mask Dispenser - Earloop Style - White Powder-Coated Steel	26	IN	7.56	4.25	4.13	LB	0.8
			CM	19.2	10.8	10.5	KG	0.3
<b>FB-090</b>	Face Mask Dispenser - Face Shield Style - White Powder-Coated Steel	26	IN	9.06	7.53	4.06	LB	1.2
			CM	23.0	19.1	10.3	KG	0.5
<b>FB-091</b>	Face Mask Dispenser - Tie Style - White Powder-Coated Steel	26	IN	7.90	7.70	5.00	LB	1.2
			CM	20.1	19.6	12.7	KG	0.5
<b>FD-005</b>	Face Mask Dispenser - Earloop Style - Bulk - White ABS Plastic & Clear PETG Plastic	17, 22	IN	8.66	4.98	4.38	LB	1.0
			CM	22.0	12.6	11.1	KG	0.4
<b>FM001-0212</b>	Face Mask Dispenser - Surgical with Dividers - Quartz Beige ABS Plastic	21, 29	IN	26.50	12.75	10.93	LB	8.3
			CM	67.3	32.4	27.7	KG	3.8



Part Number	Product Name	Page	Unit	W (L)	H	D	Product Weight	
FM002-0212	Face Mask Dispenser - Combo or Protective Wear Organizer - Compact - Quartz Beige ABS Plastic	21	IN	10.63	25.25	5.00	LB	3.3
			CM	27.0	64.1	12.7	KG	1.5
FM004-0212	Face Mask Dispenser - Surgical with Dividers and Three MP-035 Sign Holders - Quartz Beige ABS Plastic & Clear PETG Plastic	Referenced 29	IN	26.50	20.69	10.62	LB	11.0
			CM	67.3	52.6	27.0	KG	5.0
FM006-0111	Face Mask Dispenser - Shield Style - Clear PETG Plastic	26	IN	11.83	7.50	4.20	LB	0.9
			CM	30.0	19.0	10.7	KG	0.4
FM013-0212	Face Mask Dispenser - Triple - Quartz Beige ABS Plastic	28	IN	8.01	13.98	5.83	LB	1.1
			CM	20.3	35.5	14.8	KG	0.5
FM014-0212	Face Mask Dispenser - Quint - Quartz Beige ABS Plastic	Referenced 28	IN	8.01	23.11	5.83	LB	1.8
			CM	20.3	58.7	14.8	KG	0.8
FM019-0223	Face Mask Dispenser - Bulk - Countertop - White ABS Plastic & Maple Fauxwood ABS Plastic	17, 22	IN	9.45	6.75	4.75	LB	1.3
			CM	24.0	17.1	12.1	KG	0.6
FM019-0233	Face Mask Dispenser - Bulk - Countertop - Black ABS Plastic & Cherry Fauxwood ABS Plastic	17, 22	IN	9.45	6.75	4.75	LB	1.3
			CM	24.0	17.1	12.1	KG	0.6
FM063-0300	Face Mask Dispenser - Tie - Stainless Steel	21	IN	7.80	7.50	5.25	LB	1.4
			CM	19.8	19.1	13.3	KG	0.6
FM090-0300	Face Mask Dispenser - Shield - Stainless Steel	21	IN	9.06	7.53	4.06	LB	1.2
			CM	23.0	19.1	10.3	KG	0.5
FM100-0212	Face Mask Dispenser - Universal Boxed - Earloop - Quartz Beige ABS Plastic	20, 22	IN	8.25	4.63	5.75	LB	0.5
			CM	21.0	11.8	14.6	KG	0.2
FM200-0212	Face Mask Dispenser - Universal Boxed - Face Shield - Quartz Beige ABS Plastic	20, 24	IN	9.75	8.63	4.75	LB	1.0
			CM	24.8	21.9	12.1	KG	0.5
FM300-0212	Face Mask Dispenser - Universal Boxed - Cone - Quartz Beige ABS Plastic	20, 24	IN	6.75	7.13	5.75	LB	0.7
			CM	17.1	18.1	14.6	KG	0.3
FM401-0111	Face Mask Dispenser - 4" Deep, Earloop Style - Clear PETG Plastic	17, 22	IN	8.50	5.60	4.06	LB	0.8
			CM	21.5	14.2	10.3	KG	0.4
FM402-0111	Face Mask Dispenser - 4" Deep, Shield Style - Clear PETG Plastic	16, 24	IN	12.00	9.00	4.08	LB	1.5
			CM	30.5	22.9	10.4	KG	0.7
FM403-0111	Face Mask Dispenser - Large Bulk - Locking - Clear PETG Plastic	18, 22	IN	8.83	16.3	4.43	LB	1.9
			CM	21.3	41.6	11.3	KG	0.9
FM403-0212	Face Mask Dispenser - Large Bulk - Locking - Quartz Beige ABS Plastic	18, 22	IN	8.83	16.3	4.43	LB	1.9
			CM	21.3	41.6	11.3	KG	0.9
FM403-0213	Face Mask Dispenser - Large Bulk - Locking - White ABS Plastic	18, 22	IN	8.83	16.3	4.43	LB	2.0
			CM	21.3	41.6	11.3	KG	0.9
FM403-0220	Face Mask Dispenser - Large Bulk - Locking - Black ABS Plastic	18, 22	IN	8.83	16.3	4.43	LB	2.1
			CM	21.3	41.6	11.3	KG	0.9
FM403-0223	Face Mask Dispenser - Large Bulk - Locking - Maple Fauxwood ABS Plastic	18, 22	IN	8.83	16.3	4.43	LB	2.1
			CM	21.3	41.6	11.3	KG	0.9
FM403-0233	Face Mask Dispenser - Large Bulk - Locking - Cherry Fauxwood ABS Plastic	18, 22	IN	8.83	16.3	4.43	LB	2.1
			CM	21.3	41.6	11.3	KG	0.9

Part Number	Product Name	Page	Unit	W (L)	H	D	Product Weight	
FM404-0111	Face Mask Dispenser - Small Bulk - Locking - Clear PETG Plastic	19, 22	IN	8.83	10.0	4.43	LB	1.3
			CM	21.3	24.4	11.3	KG	0.6
FM404-0212	Face Mask Dispenser - Small Bulk - Locking - Quartz Beige ABS Plastic	19, 22	IN	8.83	10.0	4.43	LB	1.2
			CM	21.3	24.4	11.3	KG	0.5
FM404-0213	Face Mask Dispenser - Small Bulk - Locking - White ABS Plastic	19, 22	IN	8.83	10.0	4.43	LB	1.4
			CM	21.3	24.4	11.3	KG	0.6
FM404-0220	Face Mask Dispenser - Small Bulk - Locking - Black ABS Plastic	19, 22	IN	8.83	10.0	4.43	LB	1.4
			CM	21.3	24.4	11.3	KG	0.6
FM404-0223	Face Mask Dispenser - Small Bulk - Locking - Maple Fauxwood ABS Plastic	19, 22	IN	8.83	10.0	4.43	LB	1.3
			CM	21.3	24.4	11.3	KG	0.6
FM404-0233	Face Mask Dispenser - Small Bulk - Locking - Cherry Fauxwood ABS Plastic	19, 22	IN	8.83	10.0	4.43	LB	1.3
			CM	21.3	24.4	11.3	KG	0.6
FP-017	Face Mask Dispenser - Bulk - Cone or Pre-Assembled Eye Shields - Clear PETG Plastic	16, 24, 28, 31	IN	6.70	9.19	6.01	LB	1.2
			CM	17.0	23.3	15.3	KG	0.5
FP-021	Face Mask Dispenser - Earloop Style - Clear PETG Plastic	26	IN	7.95	4.23	5.20	LB	0.5
			CM	20.2	10.7	13.2	KG	0.2
FP-038	Face Mask Dispenser - Earloop Style - Clear PETG Plastic	26	IN	7.70	4.32	4.27	LB	0.4
			CM	19.6	11.0	10.8	KG	0.2
FP-120	Face Mask Dispenser - Shield Style - Clear PETG Plastic	26	IN	9.20	7.50	4.20	LB	0.7
			CM	23.4	19.1	10.7	KG	0.3
FS001-0111	Wax Paper Dispenser - Clear PETG Plastic	Referenced: 29	IN	6.20	10.35	2.75	LB	0.7
			CM	15.7	26.3	7.0	KG	0.3
FS001-0300	Wax Paper Dispenser - Stainless Steel	29	IN	6.06	10.29	2.62	LB	1.4
			CM	15.4	26.1	6.7	KG	0.6
GC-009	Glove Dispenser - Bulk - White Sintra® Plastic	31	IN	5.00	11.25	4.36	LB	0.5
			CM	12.7	28.6	11.0	KG	0.2
GL100-0212	Glove Box Dispenser - Single with Flexible Springs - Quartz Beige ABS Plastic	30	IN	5.84	10.11	4.22	LB	0.7
			CM	14.8	25.7	10.7	KG	0.3
GL100-1214	Glove Box Dispenser - Single with Flexible Springs - Semi-Transparent Polycarbonate Plastic	Referenced: 30	IN	5.84	10.11	4.22	LB	0.7
			CM	14.8	25.7	10.7	KG	0.3
GL300-0212	Glove Box Dispenser - Triple with Dividers - Quartz Beige ABS Plastic	Referenced: 30	IN	17.08	10.12	4.22	LB	1.4
			CM	43.4	25.7	10.7	KG	0.6
GL300-1214	Glove Box Dispenser - Triple with Dividers - Semi-Transparent Polycarbonate Plastic	4, 30	IN	17.08	10.12	4.22	LB	1.4
			CM	43.4	25.7	10.7	KG	0.6
HP-010	Hairnet Dispenser - Bulk - Clear PETG Plastic	29	IN	4.64	7.88	3.68	LB	0.7
			CM	11.8	20.0	9.3	KG	0.3
KS022-0012	Dual-Sided Floor Stand - Quartz Beige Powder-Coated Steel	5	IN	17.0	64.57	17.0	LB	17.5
			CM	43.18	164.0	43.18	KG	7.94
KS022-0020	Dual-Sided Floor Stand - Column - Black Powder-Coated Aluminum, Base - Black Powder-Coated Steel, Sign Holder - Clear PETG Plastic	Referenced 5	IN	17.0	52.9	17.0	LB	16.4
			CM	43.2	134.5	43.2	KG	7.4

Part Number	Product Name	Page	Unit	W (L)	H	D	Product Weight
KS101-0029*	Hand Sanitizer Floor Stand - Bay Gray Steel Back Plate, Column, and Base	4	IN	18.00	54.73	18.00	LB 16.0
			CM	45.7	139.0	45.7	KG 7.3
KS700-0013	Health and Hygiene Kiosk - Aluminum Composite Material, Clear Acrylic, and Boatboard	4	IN	26.0	16.0	63.2	LB 81.0
			CM	66.0	40.6	160.5	KG 36.7
MP-070	Sign Holder - Vertical - Clear PETG Plastic	28	IN	8.63	13.3	0.34	LB 1.1
			CM	21.9	35.0	0.9	KG 0.5
MP-075	Sign Holder - Horizontal - Clear PETG Plastic	28	IN	11.9	10.9	0.34	LB 1.2
			CM	21.9	35.0	0.9	KG 0.5
NC010-0111	CPR Dispenser - Clear PETG Plastic	29	IN	5.20	2.85	2.50	LB 0.2
			CM	13.2	7.2	6.4	KG 0.1
PB001-0811	Plastic Barrier - Short - Suction Cup - Clear Acrylic	15	IN	4.25	16.0	15.7	LB 2.3
			CM	10.8	40.6	40.0	KG 1.0
PB002-0811	Plastic Barrier - Small - Suction Cup - Clear Acrylic	Referenced: 15	IN	4.25	18.0	19.0	LB 3.3
			CM	10.8	45.7	48.3	KG 1.5
PB003-0811	Plastic Barrier - Medium - Suction Cup - Clear Acrylic	Referenced: 15	IN	4.25	18.0	23.5	LB 3.7
			CM	10.8	45.7	59.7	KG 1.7
PB004-0811	Plastic Barrier - Short - Clear Acrylic	15	IN	4.5	16.0	15.7	LB 2.5
			CM	11.4	40.6	40.0	KG 1.1
PB005-0811	Plastic Barrier with Sign Holder - Clear Acrylic	Referenced: 15	IN	4.5	19.2	23.6	LB 5.1
			CM	11.4	48.9	60.0	KG 2.3
PB006-0811	Plastic Barrier - Small - Clear Acrylic	Referenced: 15	IN	4.25	18.0	19.0	LB 3.3
			CM	10.8	45.7	48.3	KG 1.5
PB007-0811	Plastic Barrier - Short - with Cutaway - Clear Acrylic	Referenced: 15	IN	4.5	16.0	15.7	LB 2.3
			CM	11.4	40.6	40.0	KG 1.0
PB008-0811	Plastic Barrier - Small - with Cutaway - Clear Acrylic	Referenced: 15	IN	4.5	18.0	19.0	LB 3.1
			CM	11.4	45.7	48.3	KG 1.4
PB009-0811	Plastic Barrier - Medium - with Cutaway - Clear Acrylic	Referenced: 15	IN	4.5	18.0	23.6	LB 3.8
			CM	11.4	45.7	60.0	KG 1.7
PB010-0811	Plastic Barrier - Large - with Cutaway - Clear Acrylic	Referenced: 15	IN	4.5	18.1	29.6	LB 4.8
			CM	11.4	46.0	75.2	KG 2.2
PB011-0811	Plastic Barrier - XLarge - with Cutaway - Clear Acrylic	Referenced: 15	IN	4.5	18.1	35.6	LB 5.9
			CM	11.4	46.0	90.4	KG 2.7
PB012-1211	Protective Barrier - Pass Through Opening - XLarge - Clear Polycarbonate Plastic	15	IN	36.0	31.0	11.5	LB 9.8
			CM	91.4	78.7	29.2	KG 4.4
PB013-1211	Protective Barrier - Hinged - Small - Clear Polycarbonate Plastic & PVC Hinge	Referenced: 15	IN	31.8	23.7	0.18	LB 5.5
			CM	80.8	60.3	0.4	KG 2.5
PB014-1211	Protective Barrier - Hinged - Medium - Clear Polycarbonate Plastic & PVC Hinge	Referenced: 15	IN	40.3	23.7	0.18	LB 7.6
			CM	102.4	60.3	0.4	KG 3.4
PB015-1211	Protective Barrier - Hinged - Large - Clear Polycarbonate Plastic & PVC Hinge	15	IN	50.3	23.7	0.18	LB 9.5
			CM	127.8	60.3	0.4	KG 4.3

\*IMPORTED

Part Number	Product Name	Page	Unit	W (L)	H	D	Product Weight
PB016-1211	Protective Barrier - Medium - Clear Acrylic - Clear Polycarbonate Plastic	15	IN	28.0	23.7	7.75	LB 5.8
			CM	71.1	60.3	19.7	KG 2.6
PB017-1211	Protective Barrier - Pass Through Opening - Small - Clear Polycarbonate Plastic	Referenced: 15	IN	23.5	31.0	11.5	LB 6.9
			CM	59.7	78.7	29.2	KG 3.1
PS004-0111	Protective Wear Organizer - Glove & Bag - Clear PETG Plastic	31	IN	10.1	20.4	3.95	LB 1.2
			CM	25.7	51.8	10.0	KG 0.5
PS004-0212	Protective Wear Organizer - Glove & Bag - Quartz Beige ABS Plastic	32	IN	10.1	20.4	3.95	LB 1.3
			CM	25.7	51.8	10.0	KG 0.6
RE302-0012	Semi-Recessed Face Mask & Tissue Dispenser - Quartz Beige Powder-Coated Steel	14	IN	12.34	18.83	4.77	LB 9.4
			CM	31.3	47.8	12.1	KG 4.2
RE304-0012	Semi-Recessed Hand Sanitizer Dispenser - Quartz Beige Powder-Coated Steel	14	IN	12.35	18.85	4.22	LB 7.4
			CM	31.4	47.9	10.7	KG 3.4
RE401-0012	Semi-Recessed Face Mask & Glove Dispenser - Quartz Beige Powder-Coated Steel	14	IN	12.34	24.48	4.77	LB 11.8
			CM	31.3	62.2	12.1	KG 5.3
SN304-0713	Sign - Hand Sanitizer Station - White Sintra® Plastic	14	IN	6.30	6.00	3.71	LB 0.1
			CM	16.0	15.2	9.4	KG 0.05
TB-003	Towel Dispenser - White Powder-Coated Steel	37	IN	11.25	15.25	3.75	LB 3.9
			CM	28.6	38.7	9.5	KG 1.7
WB-711	Disposable Wipes Dispenser - Quartz Beige Powder-Coated Aluminum	28	IN	6.31	5.60	6.15	LB 0.6
			CM	16.02	14.22	15.62	KG .27

WHY BUY FROM

BOWMAN

- Quality materials and fabrication
- End user design collaboration
- Good, better, and best cost options
- Organization that improves compliance
- Purchase through your distributor
- Custom design abilities
- Unique solution driven designs
- Proudly made in Arlington, WA, USA



# organize contain comply

**ASK YOUR DISTRIBUTOR  
FOR BOWMAN PRODUCTS.  
*ACCEPT NO IMITATIONS.***

## CONTACT US

call: 800.962.4660 | fax: 360.435.5277

[CustomerService@BowmanDispensers.com](mailto:CustomerService@BowmanDispensers.com)

[www.BowmanDispensers.com](http://www.BowmanDispensers.com)

